

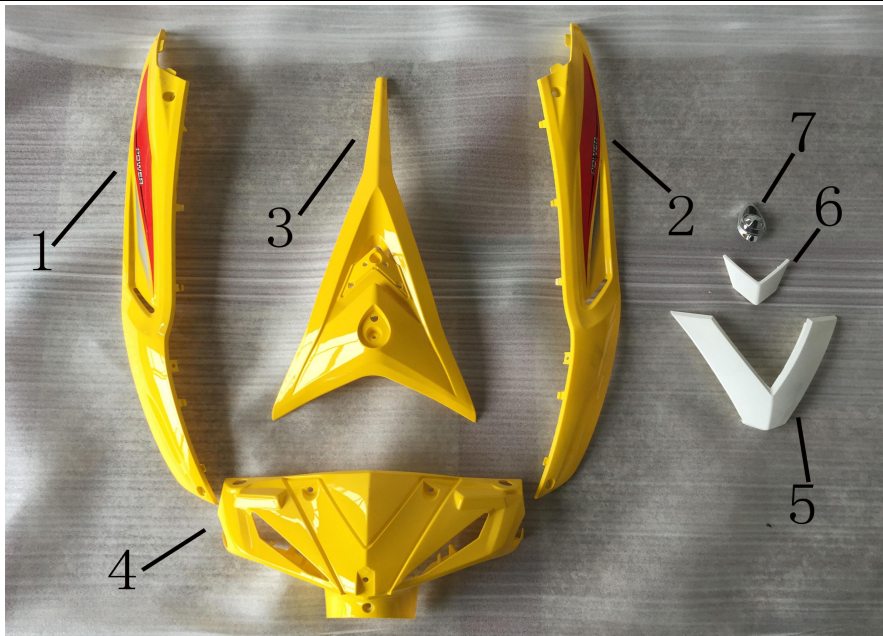

序号 SR NO.	件号 Part No.	名称 Description	名称 Description	数量 Qty
1	PST50-1-A-001	FRONT FENDER	前泥板	1
2	PST50-1-A-002	SIDE COVER CONNECTING PLATE	侧板后连接	1
3	PST50-1-A-003	FRONT COVER	前围	1
4	PST50-1-A-004	REAR SIDE COVER, LH	后左侧板	1
5	PST50-1-A-005	REAR SIDE COVER, RH	后右侧板	1



序号 SR NO.	件号 Part No.	名称 Description	名称 Description	数量 Qty
1	PST50-1-B-001	ORNEMENT PLATE, LH	左护条	1
2	PST50-1-B-002	ORNEMENT PLATE, RH	右护条	1
3	PST50-1-B-003	FACE-PLATE	前面板	1
4	PST50-1-B-004	Diversion cover	导流罩	1
5	PST50-1-B-005	Diversion cover ORNEMENT PLATE	导流罩装饰件	1
6	PST50-1-B-006	FACE-PLATE ORNEMENT PLATE	前面板V形装饰件	1
7	PST50-1-B-007	FACE-PLATE ORNEMENT PLATE, Chrome	面板装饰件（镀铬）	1



序号 SR NO.	件号 Part No.	名称 Description	名称 Description	数量 Qty
1	PST50-1-C-001	TOOL BOX	工具箱	1
2	PST50-1-C-002	INNER COVER, GLOVE BOX	工具箱内盒	1

3	PST50-1-C-003	front fender(rear)	前泥板后部	1
4	PST50-1-C-004	BOTTOM BOARD, FOOTREST	脚踏板	1
5	PST50-1-C-005	front fender(front)	前泥板前部	1
6	PST50-1-C-006	bucket seat	座桶	1
7	PST50-1-C-007	ORNAMENT BOARD, LEFT	左侧板装饰件	1
8	PST50-1-C-008	ORNAMENT BOARD, RIGHT	右侧板装饰件	1
9	PST50-1-C-009	seat front cover	杂物箱前罩	1
10	PST50-1-C-010	rear fender (center)	后泥板	1
11	PST50-1-C-011	box cap	保养盖	1
12	PST50-1-C-012	speedo shell	仪表壳	1



序号 SR NO.	件号 Part No.	名称 Description	名称 Description	数量 Qty
1	PST50-1-D-001	head light, right	前右大灯	1
2	PST50-1-D-002	head light, left	前左大灯	1
3	PST50-1-D-003	front foglight, right	前右雾灯	1

4	PST50-1-D-004	front foglight, left	前左雾灯	1
5	PST50-1-D-005	front winker RH	前右转向灯	1
6	PST50-1-D-006	front winker LH	前左转向灯	1
7	PST50-1-D-007	rear winker LH	后左转向灯	1
8	PST50-1-D-008	rear winker RH	后右转向灯	1
9	PST50-1-D-009	tail lamp	后尾灯	1
10	PST50-1-D-010	Rear license plate lamp	后牌照灯	1



序号 SR NO.	件号 Part No.	名称 Description	名称 Description	数量 Qty
1	PST50-1-E-001	harness	电缆线	1
2	PST50-1-E-002	ELECTRIC LOCK	电门锁	1
3	PST50-1-E-003	SPEEDOMETER	仪表	1
4	PST50-1-E-004	REGULATOR	稳压器	1
5	PST50-1-E-005	CDI	点火器	1
6	PST50-1-E-006	HORN	喇叭	1

7	PST50-1-E-007	BLINKER RELAY	闪光器	1
8	PST50-1-E-008	ignition coil	高压泵	1
9	PST50-1-E-009	START RELAY	启动继电器	1
10	PST50-1-E-010	Rear reflector plate	后反射器	1
11	PST50-1-E-011	Hand grip (left)	左胶套	1
12	PST50-1-E-012	Throttle grip	油门胶套	1
13	PST50-1-E-013	MIRROR, LH	左后视镜	1
14	PST50-1-E-014	MIRROR , RH	右后视镜	1

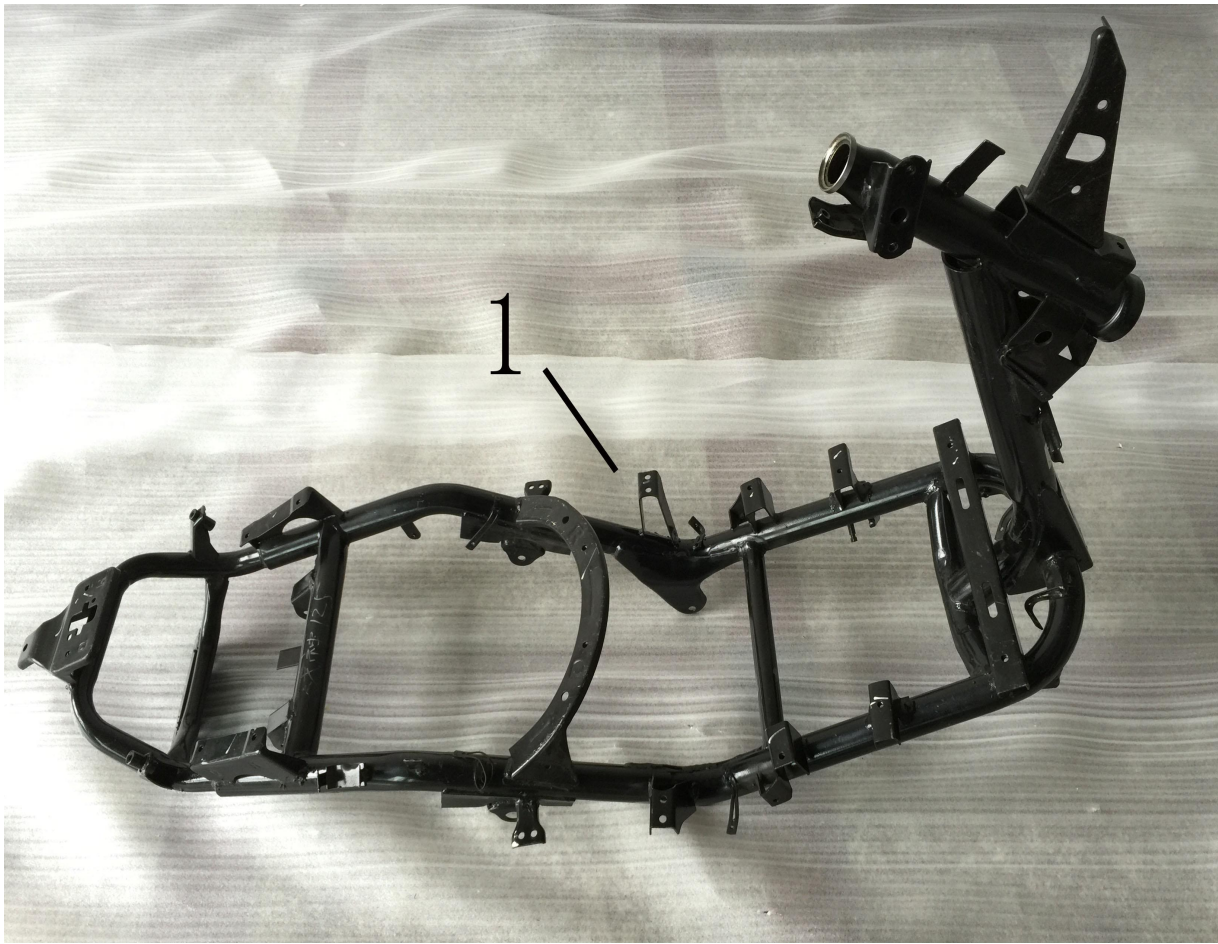

序号 SR NO.	件号 Part No.	名称 Description	名称 Description	数量 Qty
1	PST50-1-F-001	FRAME	车架	1



序号 SR NO.	件号 Part No.	名称 Description	名称 Description	数量 Qty
1	PST50-1-G-001	SHOCK, FR	前减	2
2	PST50-1-G-002	STEERING STEM	下联板	1
3	PST50-1-G-003	FUEL TANK	油箱	1
4	PST50-1-G-004	HANDLEBAR	方向把	1
5	PST50-1-G-005	fuel filter	汽油过滤器	1
6	PST50-1-G-006	oil pump	油泵	1

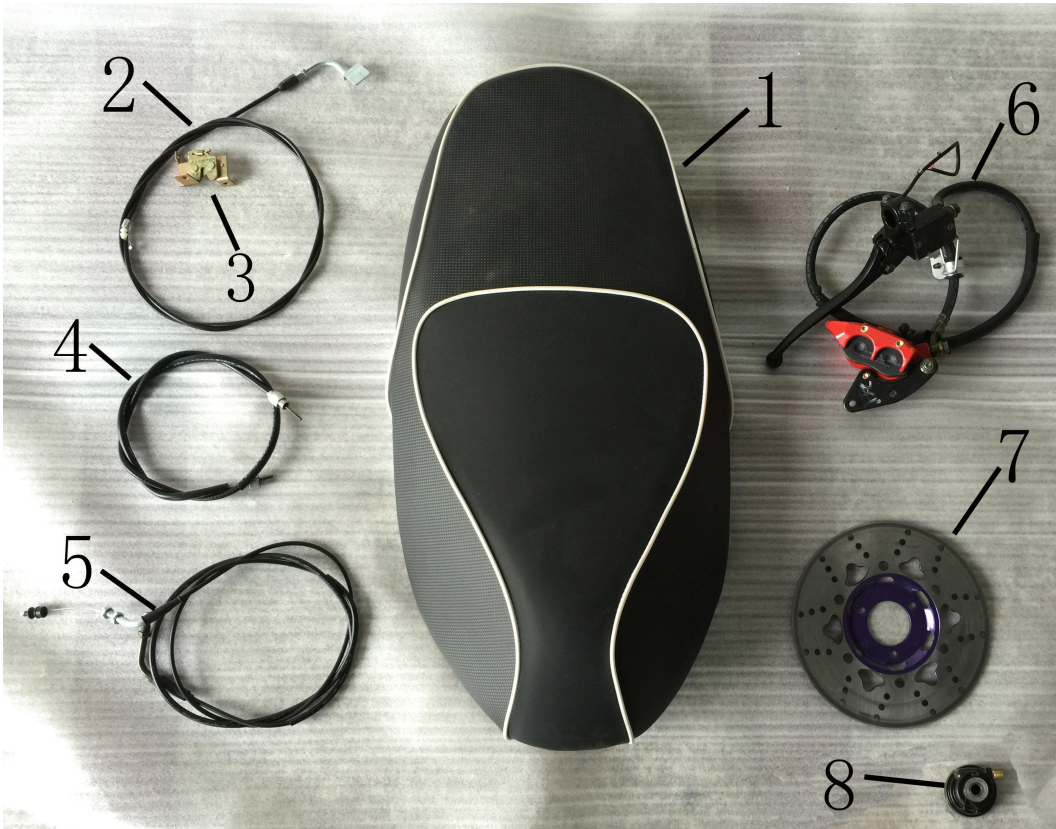

序号 SR NO.	件号 Part No.	名称 Description	名称 Description	数量 Qty
1	PST50-1-H-001	SEAT	座垫	1
2	PST50-1-H-002	seat cable	座垫拉线	1
3	PST50-1-H-003	SEAT LOCK	座垫锁	1
4	PST50-1-H-004	SPEEDOMETER CABLE	里程线	1

5	PST50-1-H-005	THROTTLE CABLE	油门线	1
6	PST50-1-H-006	FRONT DISC BRAKE	前碟刹	1
7	PST50-1-H-007	FRONT DISC PLATE	前碟刹盘	1
8	PST50-1-H-008	TACHOMETER	转速器	1
9	PST50-1-H-009	REAR FENDER	后泥板	2
10	PST50-1-H-010	REAR FENDER BRACKET	后泥板支架	2



序号 SR NO.	件号 Part No.	名称 Description	名称 Description	数量 Qty
1	PST50-1-I-001	REAR RIM	后轮钢圈	2
2	PST50-1-I-002	REAR TIRE	后轮胎	2
3	PST50-1-I-003	REAR DISC BRAKE	后碟刹	1
4	PST50-1-I-004	NUT	螺母	4



序号 SR NO.	件号 Part No.	名称 Description	名称 Description	数量 Qty
1	PST50-1-J-001	FRONT TIRE	前轮胎	1
2	PST50-1-J-002	FRONT RIM	前轮钢圈	1
3	PST50-1-J-003	NUT	螺母	1
4	PST50-1-J-004	BUSH	衬套	1
5	PST50-1-J-005	FRONT AXLE	前轮轴	1

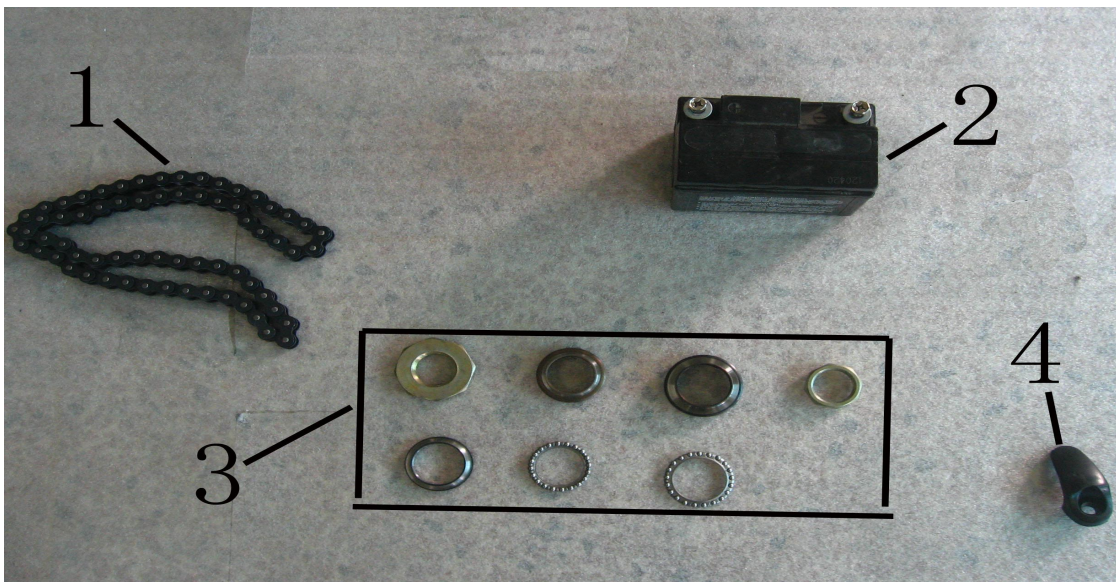

序号 SR NO.	件号 Part No.	名称 Description	名称 Description	数量 Qty
1	PST50-1-K-001	CHAIN	链条	1
2	PST50-1-K-002	BATTERY	电瓶	1
3	PST50-1-K-003	STEEL BOLL	钢碗	1
4	PST50-1-K-004	POTHOOK	头盔挂钩	1

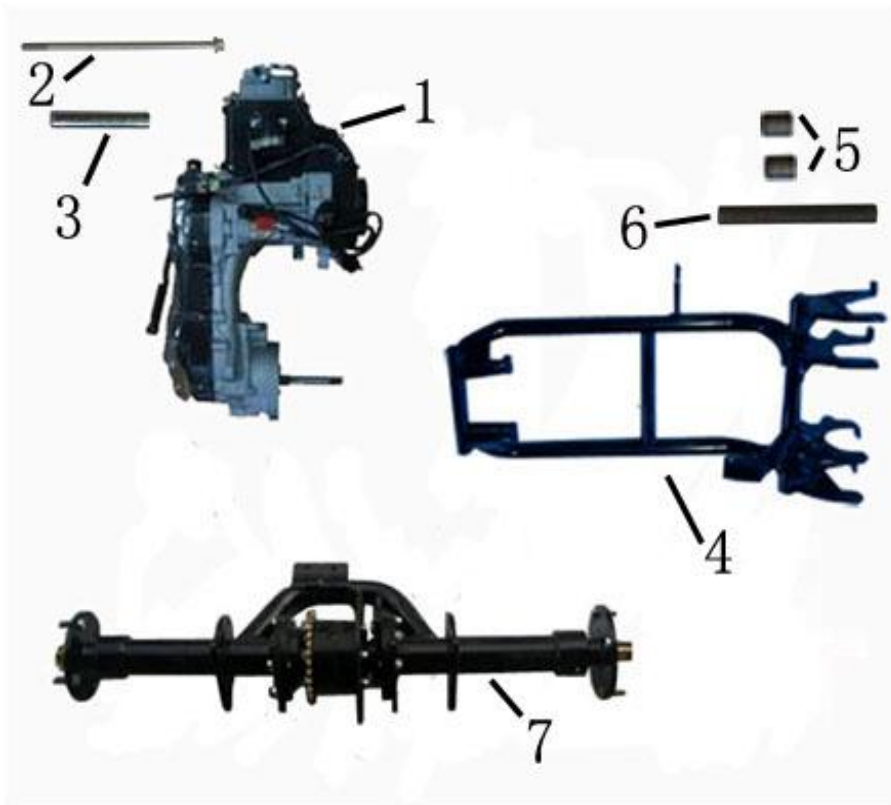

序号 SR NO.	件号 Part No.	名称 Description	名称 Description	数量 Qty
1	PST50-1-L-001	ENGINE	发动机	1
2	PST50-1-L-002	ENGINE AXLE	发动机轴	1
3	PST50-1-L-003	screened pipe	发动机衬管	1
4	PST50-1-L-004	REAR SWINGARM	后平叉	1
5	PST50-1-L-005	BUSH	衬套	2
6	PST50-1-L-006	screened pipe	衬管	1
7	PST50-1-L-007	DIFFERENTIAL	差速器	1

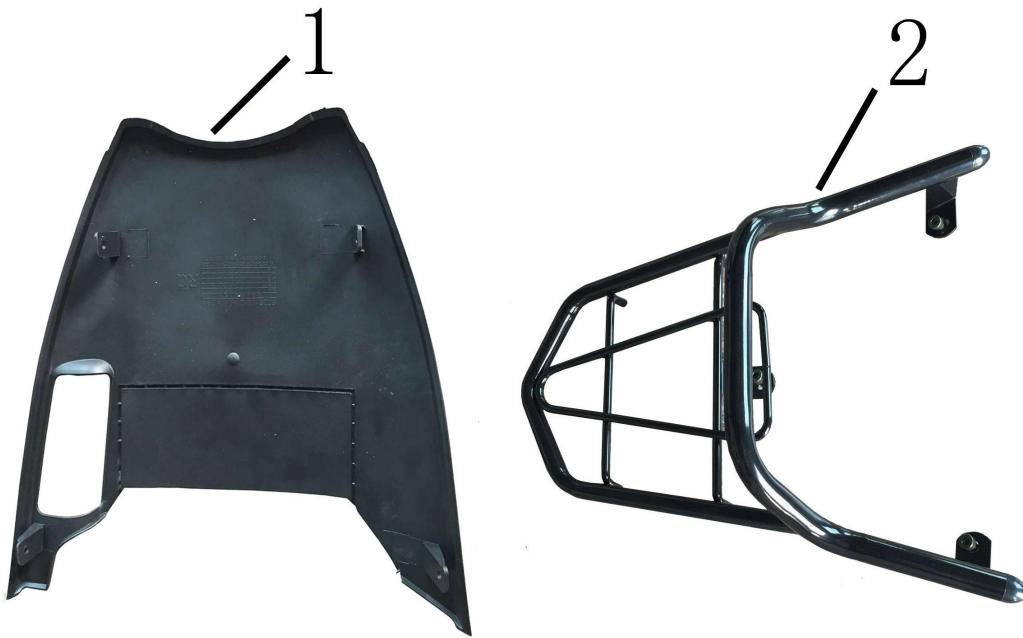

序号 SR NO.	件号 Part No.	名称 Description	名称 Description	数量 Qty
1	PST50-1-M-001		车架底板	1
2	PST50-1-M-002	REAR CARRIER	后货架	1

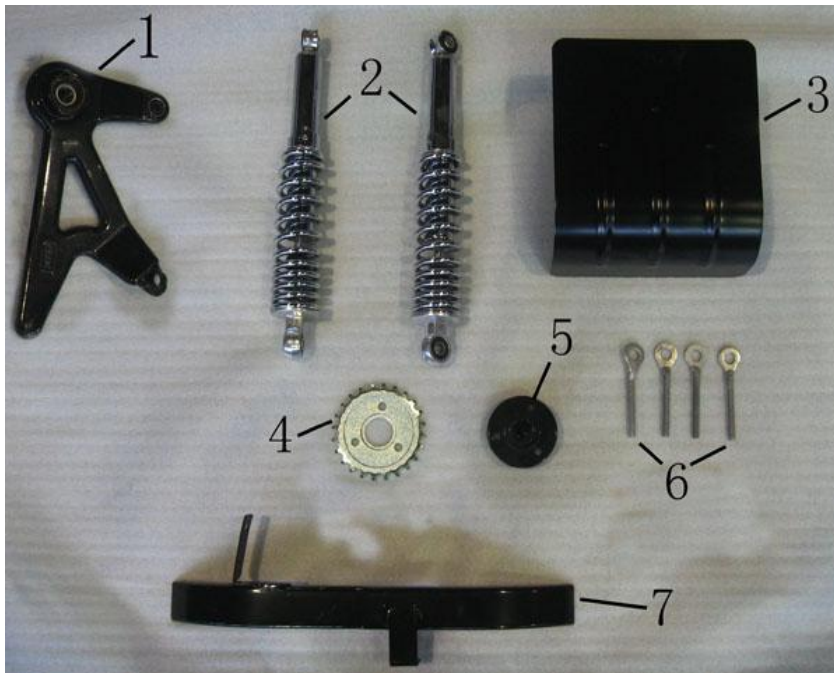

序号 SR NO.	件号 Part No.	名称 Description	名称 Description	数量 Qty

1	PST50-1-N-001	CONNECTING PLATE	三角板	1
2	PST50-1-N-002	REAR SHOCK	后减震	2
3	PST50-1-N-003	CHIAN CASE	上链罩	1
4	PST50-1-N-004	SPROCKET	链轮	1
5	PST50-1-N-005	SPROCKET HOLDER	链轮座	1
6	PST50-1-N-006	chain adjuster	调链器	4
7	PST50-1-N-007	CHIAN CASE	下链罩	1

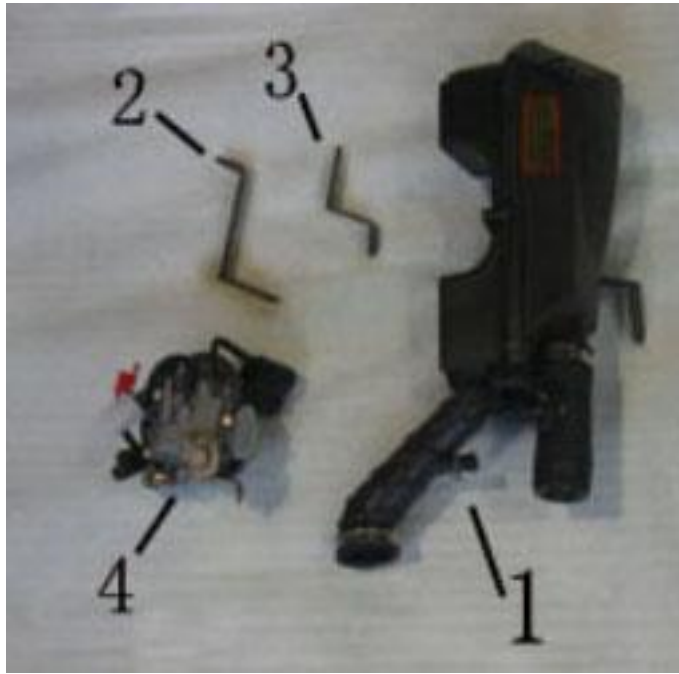

序号 SR NO.	件号 Part No.	名称 Description	名称 Description	数量 Qty
1	PST50-1-0-001	AIR FILTER	空滤	1
2	PST50-1-0-002	BRACKET 1	支架1	1
3	PST50-1-0-003	BRACKET 2	支架2	1
4	PST50-1-0-004	CARBURETOR	化油器	1



序号 SR NO.	件号 PART NO.	名称 Description	名称 Description	数量 Qty
1	PST50-1-P-001	trunk	尾箱	1
2	PST50-1-P-002	trunk holder	尾箱底板	1

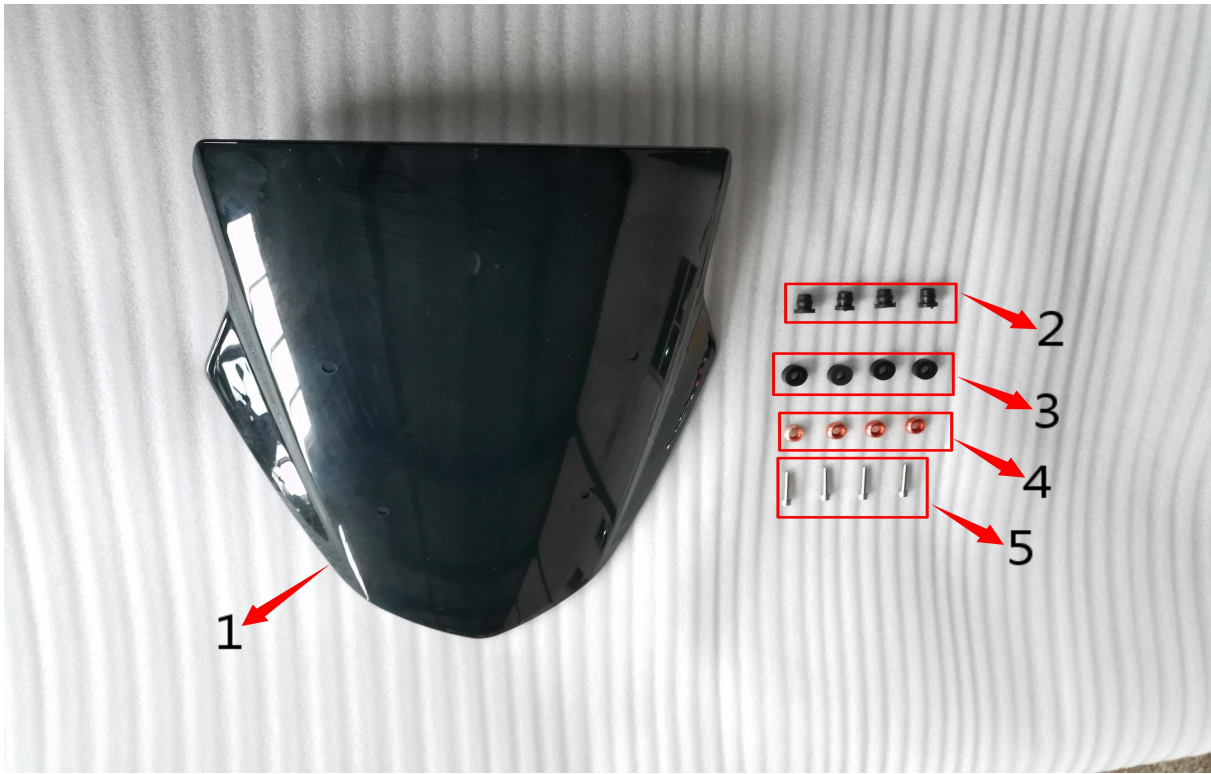

序号 SR NO.	件号 PART NO.	名称 Description	名称 Description	数量 Qty
1	PST50-1-Q-001	Windshield	挡风玻璃	1
2	PST50-1-Q-002	Nut	橡胶螺母	4
3	PST50-1-Q-003	Rubber pad	缓冲皮	4
4	PST50-1-Q-004	Ornamental buckle	装饰扣	4
5	PST50-1-Q-005	Bolt	内六角6*35螺栓	4