

USER'S MANUAL

Minimum recommend operator age : 12⁺

WARNING

Read this guide thoroughly. It contains important safety information.

Always follow this age recommendation.

Age 12 or older keep this Operator's Guide in this vehicle.



WARNING: THIS VEHICLE IS NOT FOR RACING!

ATV OPERATOR'S MANUAL

UT13

BEFORE OPERATING THIS VEHICLE, THE OWNER AND EACH OPERATOR MUST HAVE READ AND HAVE AN UNDERSTANDING OF ALL THE INSTRUCTIONS FOR PROPER ASSEMBLY AND SAFE OPERATION, AS WELL AS THE INSTRUCTIONS CONCERNING THE ENGINE AND ALL OTHER PORTIONS OF VEHICLE.



CONTENTS

1.INTRODUCTION	1
2.UNDERSTANDING WARNINGS	7
3.SAFETY WARNING	9
4.DAILY PRE-RIDE INSPECTION	13
5.OPERATION WARNINGS	14
6.V.I.N	30
7.CONTROL AND PARTS FUNCTIONS	31
8.STARTING THE ENGINE	42
9.VEHICLE BREAK-IN PERIOD	43
10.RIDING GEAR	44
11.CARRYING LOADS	45
12.RIDING	47
13.BATTERY	58
14.EXHAUST SYSTEM	61
15.MAINTENANCE	62
16.TROUBLE SHOOTING	83
17.SPECIFICATION	88
18.WIRING DIAGRAM	90

1. INTRODUCTION

Congratulations on the purchase of your ALL Terrain Vehicle (ATV). We take pride in offering you this product engineered and manufactured to the highest performance and quality standards. We are sure that you will enjoy superior levels of performance, reliability, riding comfort, and safety.

This manual is provided to help the owner and operators of this ATV become familiar with the operating characteristic, and the many features offered on the ATV. The manual also covers information on the care and maintenance of your ATV.

Please read this manual carefully. The information contained in this Owner's Manual, and the Warning Labels supplied with this product will help your ATV. Make sure you understand and follow all Warnings and Instructions in this material.

If you did not receive any of the material listed above, please call your dealer and request to have them sent to you.

Important Safety Notice

Never make any modifications to the engine, drive system, mechanical or electrical systems of your ATV. Never install after market parts or accessories intended to increase the speed or power of your ATV.

Failure to follow these warnings increases the possibility of accidents leading to **DEATH or SERIOUS INJURY!**

Additionally, failure to follow these requirements will void the Warranty on your ATV.

Note

The addition and use of certain accessories including, (but not limited to) mowers, blades, sprayers, winches and windshields will change the handling characteristics of your ATV.

Practice Responsible ATV Riding

Make sure that you understand and follow all local, state/province, and federal/national riding laws and requirements.

Remember.... Respect your vehicle, respect the environment and respect the property of others. You are responsible for your safety and the safety of others around you when you ride!



WARNING

YOUR VEHICLE CAN BE HAZARDOUS TO OPERATE.

A collision or rollover can occur quickly if you fail to take proper precautions, even during routine maneuvers such as turning and driving on hills or over obstacles.

For your safety, understand and follow all the warnings contained in this Operator's Guide and on the labels on your vehicle. **Failure to follow these warnings can result in SEVERE INJURY OR DEATH!**

Keep this Operator's Guide with the vehicle at all the times.



WARNING

Disregarding any of the safety precautions and instructions contained in this Operator's Guide and on-product labels can result in severe injury including the possibility of death.



WARNING

This product contains or emits chemicals known to the state of California to cause cancer and birth defects or other reproductive harm.

Know Before You Go

To learn how to reduce the risk for you or bystanders being injured or killed, read this Operator's Guide before you operate the vehicle.

Also, read all safety labels on your ATV.

Failure to follow the warnings contained in this Operator's Guide can result in SERIOUS INJURY or DEATH.

Age Recommendation

The vehicles are a category "Y"(Youth Model), always follow this age recommendation: is intended for recreational use by an experienced operator, age 12 or older.

These vehicles fall under the category 'Y,' designated as 'Youth Models.' It is imperative to adhere to the recommended age guidelines, as they are specifically designed for recreational use by skilled operators aged 12 years and older.

Training Course

Never operate this vehicle without proper instruction. **Take a training course.**

All operators should receive training from a certified instructor.

FOR MORE INFORMATION ABOUT ATV SAFETY, contact an authorized SYMOTOS dealer to find out about available training courses nearest you.

About this Operator's Guide

Keep this Operator's Guide in the vehicle so that you can refer to it for things such as maintenance, troubleshooting and for instructing others.

The information in this document is accurate as of the publication date. However, SYMOTOS maintains a policy of continuous improvement of its products without imposing upon itself any obligation to install them on products previously manufactured. Due to late changes, some differences between the manufactured product and the descriptions and/or specifications in this guide may occur. SYMOTOS reserves the right at any time to discontinue or change specifications, designs, features, models or equipment without incurring an obligation upon itself. This Operator's Guide should remain with the vehicle when it is sold.

Notice to Parents

Review this Operator's Guide with any user of the vehicle.

Please take time with the children to review the instructions on its safe and proper

use, and pay particular attention to the on-product safety labels, before allowing them to ride the vehicle.

Understand the controls and operation of the vehicle and carefully read the Operator's Guide.

Always remember that your approach to safety influences the child.



WARNING

This ATV is not a toy.

- Children differ in skills, physical abilities, and judgment. Some children may not be able to operate an ATV safely.
- No one under age 16 should operate an ATV without adult supervision at all times.
- Never allow continued use of the vehicle by a child if he does not have the abilities, the strength or the judgement to operate it safely.

While reading this Operator's Guide, remember that:



WARNING

Indicates a potential hazard that, if not avoided, could result in serious injury or death.

AN ATV CAN BE HAZARDOUS TO OPERATE. An ATV handles differently from other vehicles including motorcycles and cars. A collision rollover can occur quickly, even during routine maneuvers such as turning and driving on hills or over obstacles, if you fail to take proper precautions.



SERIOUS INJURY OR DEATH can result if you do not follow these instructions.

- Read this manual and all labels carefully and follow the operating procedures described.
- Never operate an ATV without proper instruction. Take a training course. Beginners should receive training from a certified instructor. Contact an authorized ATV dealer to find out about the training courses nearest you.
- Do not let the minors under the age of 12 to drive the ATV.
- Never permit a guest to operate this ATV unless the guest has read this manual and all product labels and has completed a certified training course.
- Always avoid operating an ATV on any paved surfaces, including sidewalks, driveways, parking lots and streets.
- Never operate an ATV without wearing an approved helmet that fits properly. You should also wear eye protection (goggles or face shield), gloves, boots, a

long-sleeved shirt or jacket, and long pants.

- Never consume alcohol or drugs before or while operating this ATV.
- Never operate at excessive speeds. Always travel at a speed which is proper for the terrain, visibility and operating conditions, and your experience.
- Never attempt wheelies, jumps or other stunts.
- Always inspect your ATV each time you use it to make sure it is in a safe operating condition. Always follow the inspection and maintenance procedures and schedules described in this manual.
- Always keep both hands on the handlebars and both feet on the footrests of the ATV during operation.
- Always go slowly and be extra careful when operating on an unfamiliar terrain. Always be alert to changing terrain conditions when operating the ATV.
- Never operate on excessively rough, slippery or loose terrain.
- Always follow proper procedures for turning as described in this manual. Practice turning at low speeds before attempting to turn at faster speeds. Do not turn at excessive speeds.
- Always have the ATV checked by an authorized dealer if it has been involved in an accident.
- Never operate ATV on hills too steep for the ATV or for your abilities. Practice on smaller hills before attempting larger hills.
- Always follow proper procedures for climbing hills as described in this manual. Check the terrain carefully before you start up any hill. Never climb hills with excessively slippery or loose surfaces. Shift your weight forward. Never open the throttle suddenly or make sudden gear changes. Never go over the top of any hill at high speed.
- Always follow proper procedures for going downhill and for braking on hills as described in this manual. Check the terrain carefully before you start down any hill. Shift your weight backward. Never go down a hill at high speed. Avoid going down a hill at an angle, which would cause the vehicle to lean sharply to one side. Go straight down the hill when possible.
- Always follow proper procedures for crossing the side of a hill as described in this manual. Avoid hills with excessively slippery or loose surfaces. Shift your weight to the uphill side of the ATV. Never attempt to turn the ATV around on any hill until you have mastered the turning technique described in this manual on level ground. Avoid crossing the side of a steep hill when possible.
- Always use proper procedures if you stall or roll backwards when climbing a hill. To avoid stalling, maintain steady speed when climbing a hill. If you stall or roll backwards, follow the special procedure for braking described in this manual. Dismount on the uphill side, or to either side if pointed straight uphill. Turn the ATV around and remount, following the procedure described in this manual.
- Always check for obstacles before operating in a new area. Never attempt to operate over large obstacles, such as large rocks or fallen trees. Always follow proper procedures when operating over obstacles as described in this manual.
- Always be careful of skidding or sliding. On slippery surfaces, such as ice, go

slowly and be very cautious in order to reduce the chance of skidding or sliding out of control.

- Avoid operating the ATV through deep or fast-flowing water. Avoid water which exceeds the recommended maximum depth, go slowly, balance your weight carefully avoiding sudden movements, and maintain a slow and steady forward motion. Do not make sudden turns or stops, and do not make sudden throttle changes.
- Wet brakes may have reduced stopping ability. Test your brakes after leaving water. If necessary, apply them lightly several times to let friction dry out the pads.
- Always be sure there are no obstacles or people behind you when you operate in reverse. When it is safe to proceed in reverse, go slowly. Avoid turning at sharp angles in reverse.
- Always use the size and type of tires specified in this manual: "17. SPECIFICATION".
- Always maintain proper tire pressure as described in this manual: "17. SPECIFICATION".
- Never modify an ATV through improper installation or use of accessories.
- Never exceed the stated load capacity for an ATV. Cargo should be properly distributed and securely attached. Reduce speed and follow instructions in this manual for carrying cargo. Allow greater distance for braking.

2. UNDERSTANDING WARNINGS

ATTENTION:

THIS VEHICLE IS NOT A TOY!

READ AND UNDERSTAND WARNINGS AND OWNER'S MANUAL BEFORE OPERATION

 **KNOW YOUR VEHICLE BEFORE YOU BEGIN RIDING!**

Read this manual thoroughly referring to the various areas which are being discussed on your machine. Operating this vehicle carries with its responsibilities for your personal safety, the safety of others, and the protection of our environment.

NOTE: Illustrations used in this manual are for general representation only. Your model may differ.

Safety Alert

WARNINGS identify special instructions or procedures which, if not correctly followed, could result in personal injury, or loss of life. Read all WARNINGS in this manual carefully. Follow their instructions to remain safe.

The following precautionary signal words are used throughout this manual to convey the following messages:



This is the safety alert symbol. When you see this symbol on your machine or in this manual, be alert to the potential for personal injury. Your safety is involved!



WARNING

Indicates a potential hazard which could result in severe injury or death.



CAUTION

Indicates a potential hazard which may result in minor personal injury or damage to the ATV.



CAUTION

Indicates a situation that can result in damage to the machine.

NOTE

The word "NOTE" in this manual will alert you to key information or instructions.

3. SAFETY WARNING

NOTE:

Warning decals have been placed on the vehicle for your protection. Read and follow the instructions on each decal carefully. In the event any decal becomes illegible or comes off, contact your dealer for a replacement.

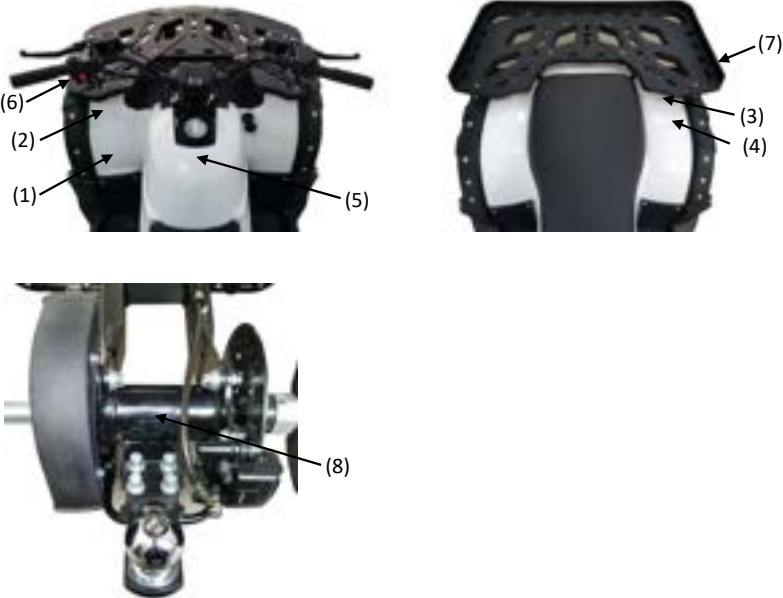

1. General Warning Label



2. Age Recommendation Warning Label



3. Combined Tire Pressure and Overloading Warning Label



4. Passenger Warning Label



5. Certification Label



6. Front Rack Label

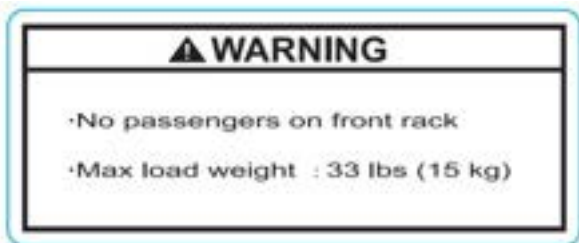

7.Rear Rack Label

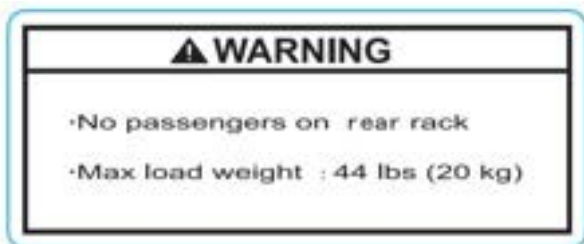

8.Trailer Label



4. DAILY PRE-RIDE INSPECTION



WARNING

You must inspect your ATV each time before riding to ensure it is in proper working order. If proper inspection is not done, severe injury or death could result.

Use the following checklist to verify your machine is in proper working order each time you ride.

Item/Inspection procedure

1. Tire-check condition and pressures.
2. Fuel tank-fill the fuel tank to its proper level.
3. All brakes-check operation, adjustment and fluid level (includes auxiliary brake).
4. Throttle-check for free operation and closing.
5. Headlight / Taillight / Brakelight-check operation of all indicator lights and switches.
6. Engine stop switch-check for proper function.
7. Wheels-check for tightness of wheel nuts and axle nuts; check that axle nuts are secured by cotter pins.
8. Air cleaner element-check for dirt; clean or replace.
9. Steering-check for free operation noting any unusual looseness in any area.
10. Loose parts-visually inspect vehicle for any damaged components or loose nuts/bolts or fasteners.
11. Operators' helmets, goggles and clothing.

5. OPERATION WARNINGS



WARNING

POTENTIAL HAZARD

Operating this ATV without proper instruction.

WHAT CAN HAPPEN

The risk of an accident is greatly increased if the operator does not know how to operate the ATV properly in different situations and on different types of terrain.

HOW TO AVOID THE HAZARD

Beginning and inexperienced operators should complete the certified training course.

They should then regularly learn techniques described in the Owner's Manual.

For more information about the training course, contact an authorized ATV dealer.



WARNING

POTENTIAL HAZARD

Operating this ATV without wearing an approved helmet, eye protection and protective clothing.

WHAT CAN HAPPEN

Operating without an approved helmet increases your chances of a severe head injury or death in the event of an accident.

Operating without eye protection can result in an accident and increases your chances of a severe injury in the event of an accident.

HOW TO AVOID THE HAZARD

Always wear an approved helmet which fits properly.

You should also wear: eye protection (goggles or face shield), gloves, boots, long-sleeved shirt or jacket, and long pants.



WARNING



POTENTIAL HAZARD

Carrying a passenger on this ATV.

WHAT CAN HAPPEN

Greatly reduces your ability to balance and control this ATV.

Could cause an accident, resulting in harm to you and /or your passenger.

HOW TO AVOID THE HAZARD

Never carry a passenger.



WARNING

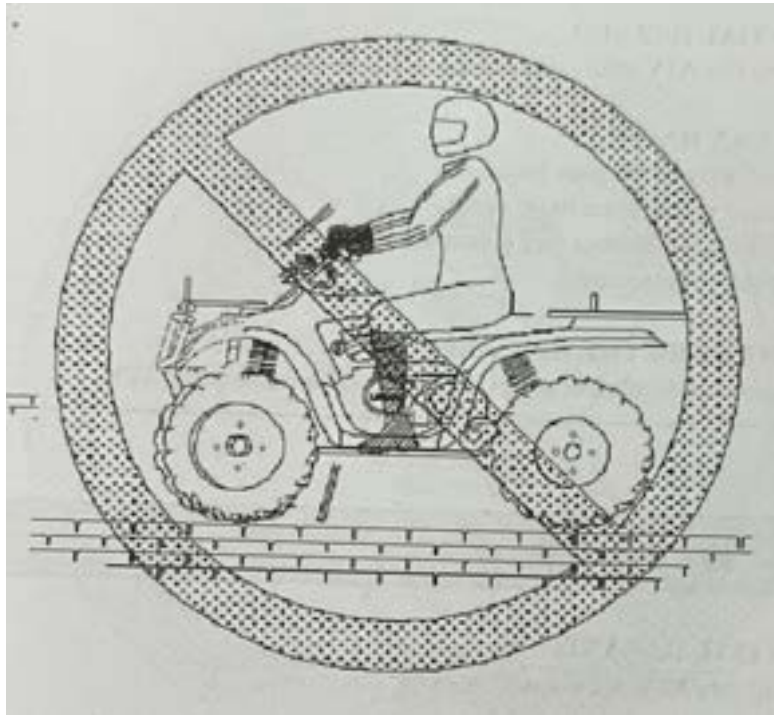

POTENTIAL HAZARD

Operating this ATV on paved surfaces, including sidewalks, paths, parking lots, and driveways.

WHAT CAN HAPPEN

Paved surfaces may seriously affect the handling and control of the ATV, and may cause the vehicle to go out of control.

HOW TO AVOID THE HAZARD

Avoid operating the ATV on pavement.



WARNING

POTENTIAL HAZARD

Operating this ATV after consuming alcohol or drugs.

WHAT CAN HAPPEN

Could seriously affect your judgment.
Could cause you to react more slowly.
Could affect your balance and perception.
Could result in an accident.

HOW TO AVOID THE HAZARD

Never consume alcohol or drugs before or while driving this ATV.



WARNING

POTENTIAL HAZARD

Operating this ATV at excessive speeds.

WHAT CAN HAPPEN

Increases your chance of losing control of the ATV, which can result in an accident.

HOW TO AVOID THE HAZARD

Always travel at a speed which is proper for the terrain, visibility and operating conditions, and your experience.



WARNING

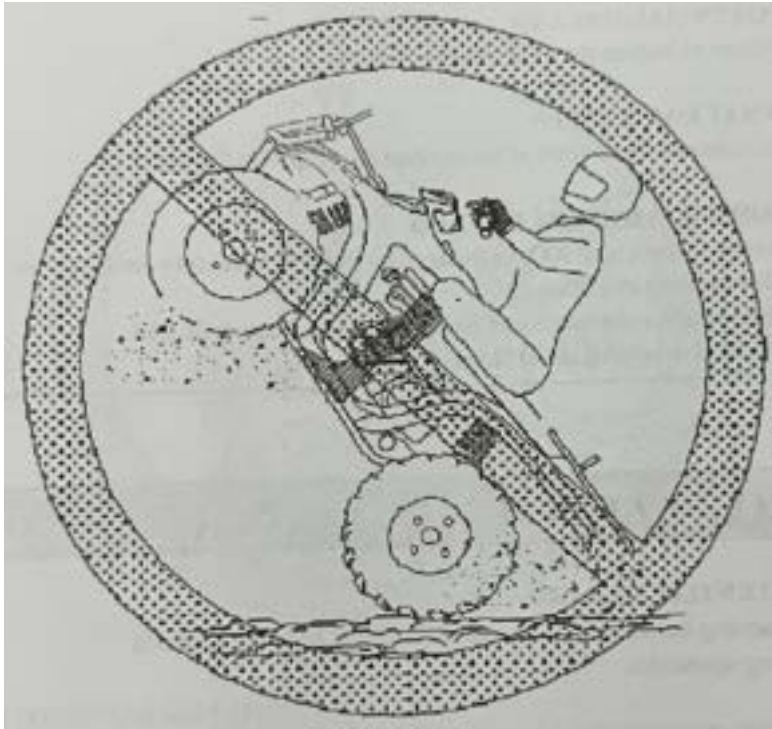

POTENTIAL HAZARD

Attempting wheelies, jumps and other stunts.

WHAT CAN HAPPEN

Increases the chance of an accident, including an overturn.

HOW TO AVOID THE HAZARD

Never attempt stunts, such as wheelies or jumps.



WARNING

POTENTIAL HAZARD

Failure to inspect the ATV before operating.

WHAT CAN HAPPEN

Increases the possibility of an accident or equipment damage.

HOW TO AVOID THE HAZARD

Always inspect your ATV each time you use it to make sure the ATV is in safe operating condition.

Always follow the inspection and maintenance procedures and schedules described in the Owner's Manual.



WARNING

POTENTIAL HAZARD

Removing hands from the handlebars or feet from the footrests during operation.

WHAT CAN HAPPEN

Removing even one hand or foot can reduce your ability to control the ATV or could cause you to lose your balance and fall off the ATV. If you remove a foot from the footrest, your foot or leg may come into contact with the rear wheels, which could injure you or cause an accident.

HOW TO AVOID THE HAZARD

Always keep both hands on the handlebars and both feet on the footrests of your ATV during operation.



WARNING

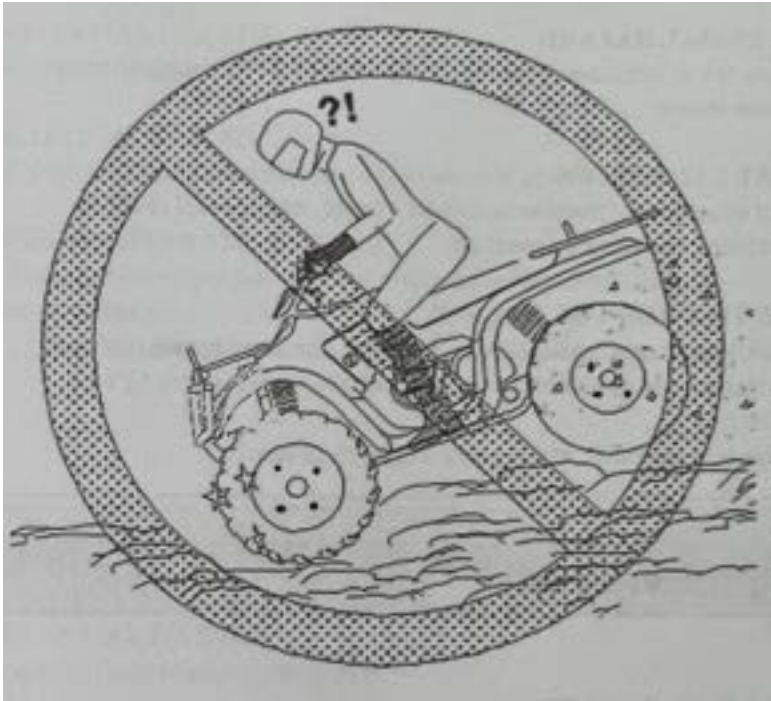

POTENTIAL HAZARD

Failure to use extra care when operating this ATV on unfamiliar terrain.

WHAT CAN HAPPEN

You can come upon hidden rocks, bumps, or holes, without enough time to react. Could result in the ATV overturning or going out of control.

HOW TO AVOID THE HAZARD

Go slowly and be extra careful when operating on unfamiliar terrain. Always be alert to changing terrain conditions when operating the ATV.



WARNING

POTENTIAL HAZARD

Failure to use extra care when operating on excessively rough, slippery or loose terrain.

WHAT CAN HAPPEN

Could cause loss of traction or vehicle control, which could result in an accident, including an overturn.

HOW TO AVOID THE HAZARD

Do not operate on excessively rough, slippery or loose terrain until you have learned and practiced the skills necessary to control the ATV on such terrain.

Always be especially cautious on these kinds of terrain.



WARNING

POTENTIAL HAZARD

Climbing hills improperly.

WHAT CAN HAPPEN

Could cause loss of control or cause ATV to overturn.

HOW TO AVOID THE HAZARD

Always follow proper procedures for climbing hills as described in the Owner's Manual.

Always check the terrain carefully before you start up any hill.

Never climb hills with excessively slippery or loose surfaces.

Shift your weight forward.

Never open the throttle suddenly. The ATV could flip over backwards.

Never go over the top of any hill at high speed. An obstacle, a sharp drop, or another vehicle or person could be on the other side of the hill.



WARNING

POTENTIAL HAZARD

Turning improperly.

WHAT CAN HAPPEN

ATV could go out of control, causing a collision or overturn.

HOW TO AVOID THE HAZARD

Always follow proper procedures for turning as described in the Owner's Manual.



WARNING

POTENTIAL HAZARD

Operating on excessively steep hills.

WHAT CAN HAPPEN

The vehicle can overturn more easily on extremely steep hills than on level surfaces or small hills.

HOW TO AVOID THE HAZARD

Never operate the ATV on hills too steep for the ATV or for your abilities.

Practice on smaller hills before attempting large hills

Never operate ATV on hills steeper than 15°.



WARNING

POTENTIAL HAZARD

Going down a hill improperly.

WHAT CAN HAPPEN

Could cause loss of control or cause ATV to overturn.

HOW TO AVOID THE HAZARD

Always follow proper procedures for going down hills as described in the Owner's Manual.

NOTE:A special technique is required when braking as you go downhill.

Always check the terrain carefully before you start down any hill.

Shift your weight backward.

Never go down a hill at high speed.

Avoid going down a hill at an angle which would cause the vehicle to lean sharply to one side. Go straight down the hill when possible.



WARNING

POTENTIAL HAZARD

Improperly crossing hills or turning on hills.

WHAT CAN HAPPEN

Could cause loss of control or cause ATV to overturn.

HOW TO AVOID THE HAZARD

Never attempt to turn the ATV around on any hill until you have mastered the turning technique as described in the Owner's Manual on level ground. Be very careful when turning on any hill.

Avoid crossing the side of a steep hill if possible.

When crossing the side of a hill:

Always follow proper procedures as described in the Owner's Manual.

Avoid hills with excessively slippery or loose surfaces.

Shift your weight to the uphill side of the ATV.



WARNING

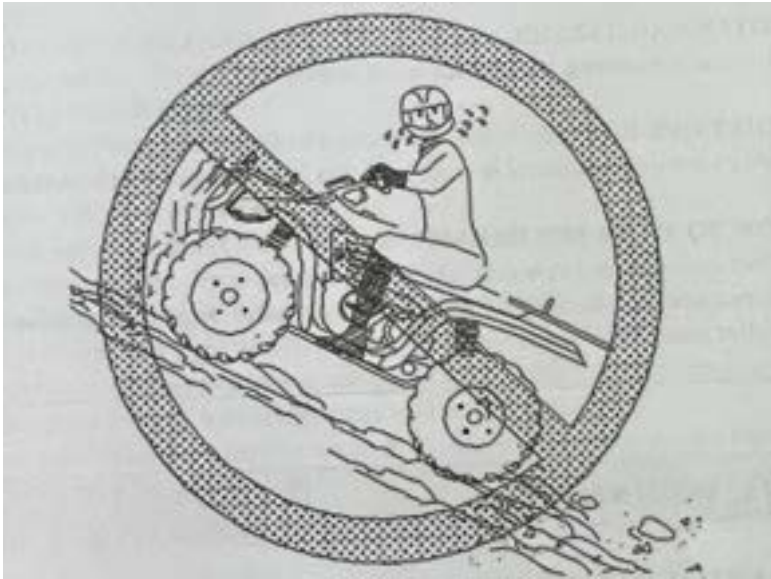

POTENTIAL HAZARD

Stalling, rolling backwards or improperly dismounting while climbing a hill.

WHAT CAN HAPPEN

Could result in ATV overturning.

HOW TO AVOID THE HAZARD

Maintain steady speed when climbing a hill.

If you lose all forward speed:

Keep your weight uphill.

Apply the brakes.

Lock parking brake after you are stopped.

If the ATV begins rolling backwards:

Keep weight uphill; never apply engine power.

Never apply the rear brake while rolling backwards.

Apply the single-lever brake gradually.

When fully stopped, apply the rear brake as well, and then lock the parking brake.

Dismount on uphill side, or to either side if pointed straight uphill.

Turn the ATV around and remount, following the procedure described in the Owner's Manual.



WARNING

POTENTIAL HAZARD

Improperly operating over obstacles.

WHAT CAN HAPPEN

Could cause loss of control or a collision. Could cause the ATV to overturn.

HOW TO AVOID THE HAZARD

Before operating in a new area, check for obstacles.

Use extreme caution when riding over large obstacles, such as large rocks or fallen trees.



WARNING

POTENTIAL HAZARD

Skidding or sliding.

WHAT CAN HAPPEN

You may lose control of the ATV.

You may also regain traction unexpectedly, which may cause the ATV to overturn.

HOW TO AVOID THE HAZARD

On slippery surfaces, such as ice, go slowly and be very cautious in order to reduce the chance of skidding or sliding out of control.



WARNING

POTENTIAL HAZARD

Operating this ATV through deep or fast-flowing water.

WHAT CAN HAPPEN

Tires may float, causing loss of traction and loss of control, which could lead to an accident.

HOW TO AVOID THE HAZARD

Never operating the ATV through water which exceeds the recommended maximum depth in this manual.

Avoid operating the ATV through deep or fast-flowing water. If you cannot avoid water, go slowly, balance your weight carefully avoiding sudden turns or stops, and do not make sudden throttle changes.

Remember that wet brakes may have reduced stopping ability.

Test your brakes after leaving water. If necessary, apply them several times to let friction dry out the pads.



WARNING

POTENTIAL HAZARD

Improperly operating in reverse.

WHAT CAN HAPPEN

You could hit an obstacle or person behind you, resulting in severe injury.

HOW TO AVOID THE HAZARD

When you select reverse gear, make sure there are no obstacles or people behind you. When it is safe to proceed, go slowly.



WARNING

POTENTIAL HAZARD

Operating this ATV with improper tires, or with improper or uneven tire pressure.

WHAT CAN HAPPEN

Use of improper tires on this ATV, or operation of this ATV with improper or uneven tire pressure, may cause loss of control, and increases the risk of an accident.

HOW TO AVOID THE HAZARD

Always use the size and type of tires specified in the Owner's Manual for this vehicle.

Always maintain proper tire pressure as described in the Owner's Manual.



WARNING

POTENTIAL HAZARD

Operating this ATV with improper modifications.

WHAT CAN HAPPEN

Improper installation of accessories or modification of this vehicle may cause changes in handling which in some situations could lead to an accident.

HOW TO AVOID THE HAZARD

Never modify this ATV through improper installation or use of accessories.

All parts and accessories added to this vehicle should be genuine or equivalent components designed for use on this ATV and should be installed and used according to instructions. If you have questions, consult an authorized dealer.



WARNING

POTENTIAL HAZARD

Overloading this ATV or carrying or towing cargo improperly.

WHAT CAN HAPPEN

Could cause changes in vehicle handling, which could lead to an accident.

HOW TO AVOID THE HAZARD

Never exceed the stated load capacity for this ATV.

Cargo should be properly distributed and securely attached.

Reduce speed when carrying cargo or pulling a trailer.

Allow a greater distance for braking.

Always follow the instructions in the Owner's Manual for carrying cargo or pulling a trailer.



WARNING

POTENTIAL HAZARD

Riding on frozen lakes and rivers.

WHAT CAN HAPPEN

Severe injury or death can result if the ATV and/or the operator break through the ice.

HOW TO AVOID THE HAZARD

Never ride your ATV on a frozen body of water before you are sure the ice is thick enough and sound enough to support the machine and its operator, as well as the force that is created by a moving vehicle.



WARNING

After a rollover or an accident, have a qualified service dealer check the complete machine including, but not limited to, brakes, throttle and steering for possible damage.



WARNING

Safe operation of this ride active vehicle requires good judgment and physical skills. Persons with cognitive or physical disabilities who operate this vehicle have an increased risk of overturns and loss of control which could result in severe injury or death.



CAUTION

Keep combustible materials away from exhaust system. Fire may result.

6. V.I.N



Record these numbers from your ATV in the spaces provided.

1. Frame VIN (on the left side of the front bottom beam)
2. Engine Serial Number (on the left side of the box)

Remove the spare key and store in a safe place. Your key can be duplicated only by obtaining a key blank and having it cut by mating it with your existing.

The vehicle frame and engine serial numbers are important for model identification when registering your vehicle, obtaining insurance or whenever replacement parts are required. In the event your vehicle were stolen these numbers are essential to the recovery and identification of your ATV.

7. CONTROL AND PARTS FUNCTIONS

Electrical Switches



1. **Main Switch (1)** - This key switch must be turned clockwise to the "on" position to turn on the vehicle power.
2. **Engine Starting switch (2)**- Squeezing the brake lever and press the starting switch, engine starting.
3. **Engine stop switch (3)**- Engine stop switch in the middle , the engine can be started. When push to the left or right, turn off the engine .

Light Switches



WARNING

This ATV is not equipped with highway approved lighting. This ATV is designed for off-road use only and must not be ridden on streets or highways. Use caution and drive at reduced speeds in conditions of reduced visibility such as fog, rain and darkness.

Switches

The light switch is located on the left hand handlebar. In addition to turning the lights on and off, it also switches the lights from to Lo on models equipped with Hi-Lo beams.

NOTE: Will not light unless the main switch is on.

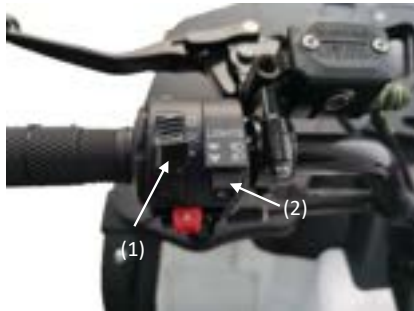

Turn the light switch(1) to the " • "position to turn off all light.

Turn the light switch(1) to the " P "position to turn on the taillight.

Turn the light switch(1) to the " ☞ "position to turn on the headlight.

A. Press the headlight dimmer switch(2) out "☞"position, switch on the low beam.

B. Press the headlight dimmer switch(2) in "☞"position, switch on the high beam.

Indicator Lights

The ATV has indicator lights (1).

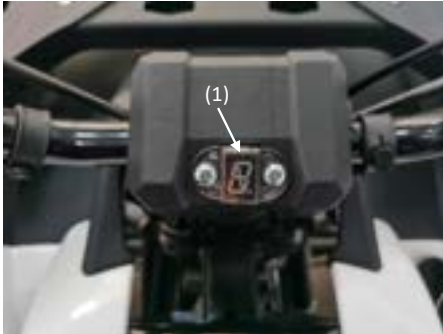

Indicate Neutral N
Indicate Reverse R
Indicate First 1
Indicate Second 2
Indicate Third 3

Throttle



WARNING

Do not start or operate an ATV with sticking or improperly operating throttle controls. A sticking or improperly operating throttle could cause an accident resulting in severe injury or death.

Always contact your dealer for service repairs whenever throttle problems arise.

Failure to check or maintain proper operation of the throttle system can result in the throttle lever sticking during riding and cause an accident.

Always check the lever for free movement and return before starting the engine and occasionally during riding.

Throttle Lever

Engine speed and vehicle movement are controlled by pressing the throttle lever. The throttle lever (1) is spring loaded and engine speed returns to idle when the lever is released.



WARNING

Washing or operating the scooter in freezing temperatures can result in water freezing in the throttle cable conduit and/or on the throttle mechanism. This may result in the throttle sticking which can cause the engine to continue to run and result in loss of control.

Front and Rear Brakes

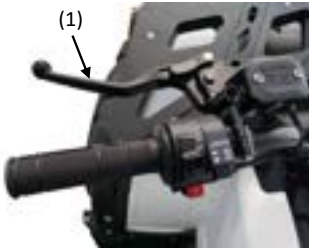

(1) Rear brake lever



(2) Front brake lever

FRONT BRAKE LEVER

The front brake lever(2) is next to the right handgrip.

The front brakes is operated by squeezing the front brake lever.

REAR BRAKE LEVER

The rear brake lever(1) is next to the left handgrip.

The rear brake is operated by squeezing the rear brake lever.

Brake fluid box

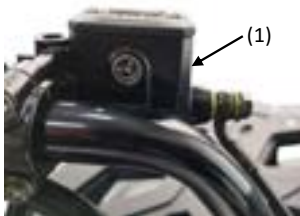

(1) Rear brake fluid box



(2) Front brake fluid box

1. Front brake fluid box (2) is mounted on the right handlebar by hand manipulation.
2. Rear brake fluid box (1) is mounted on the left handlebar by hand manipulation.
3. Before driving, the brake fluid level must be checked every time, the fluid level should be maintained above the limit mark.



CAUTION

Once a bottle of brake fluid is opened, use what is necessary and discard the rest. Do not store or use a partial bottle of brake fluid. Brake fluid is hygroscopic, meaning it rapidly absorbs moisture from the air. This causes the boiling temperature of the brake fluid to drop, which can lead to early brake fade and the possibility of severe injury.

Prior to each use, please ensure you check the brake lever, brake pedal, and the brake fluid level.

If you experience a strong resistance when depressing the pedal or squeezing the brake lever, it indicates proper brake functionality. However, if you notice a soft or weak response, it may indicate potential issues such as brake fluid leaks or low fluid levels. It's essential to investigate and rectify any such issues before operating the vehicle.

Please go to the SYMOTOS authorized dealer for checking and repairing.



WARNING

Never operate the ATV with a spongy-feeling brake lever. Operating the ATV with a spongy brake lever can result in loss of braking. Loss of braking could cause an accident.

The brake in the ATV is a safety device.

If the rear wheel slips, please decrease the braking force to some extent. Please do not force use of the rear brake when ATV slips down the hill, otherwise, it can lead to roll down from the hill.

NOTE: When checking the brake fluid, the ATV must be parked at the level of the ground, put the handle bar in positive direction. If the fluid level is low as DOT 3 only.

Setting the Parking Brake

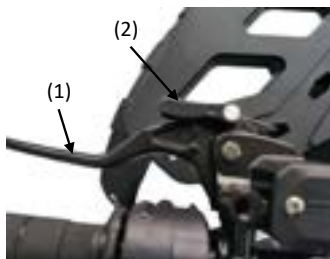

(1) Rear parking brake



(3) Front parking brake

1. Squeeze the right hand brake lever (3) two or three times and hold it.
2. Press down the parking hinge pin(4), put the parking lock into the groove and then loose the brake bar. Now the front brake of ATV is in the parking condition.
3. Squeeze the right hand brake lever (1) two or three times and hold it.
4. Press down the parking hinge pin(2), put the parking lock into the groove and then loose the brake bar. Now the rear brake of ATV is in the parking condition.
5. Bridle the right hand brake lever, and loosen the parking lock, then the front brake of ATV can be reinstated.
6. Bridle the left hand brake lever, and loosen the parking lock, then the rear brake of ATV can be reinstated.

Important Safeguards

- The parking brake may relax when left on for a long period of time. This could cause an accident.
- Do not leave the vehicle on a hill depending on the parking brake for more than five minutes.**
- Always block the downhill side of the wheels if leaving the ATV on a hill or park the ATV in a side hill position.



WARNING

Always check to be sure that the parking brake has been disengaged before operating the ATV. An accident could result causing severe injury if the parking brake is left on while the ATV is operated.

Gearshift

The shift mechanism is installed on the left side of the vehicle near pedal position. The shift lever has five kinds of state can be choose: reverse, neutral, 1 forward gear, 2 forward gear, 3 forward gear.

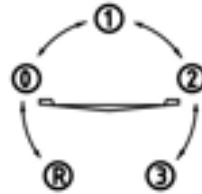

CAUTION

Always place the transmission in gear with the parking brake locked whenever the vehicle is left unattended.

Maintain the correct adjustment of the gear shift rod has an important role in maintaining the performance of the transmission system. Should you experience any shifting problem see your dealer.



WARNING

POTENTIAL HAZARD

Engaging a lower gear when the engine speed is too high.

WHAT CAN HAPPEN

The wheels could stop rotating. This could cause loss of control, an accident and an injury. It could also cause engine or drive train damage.

HOW TO AVOID THE HAZARD

Ensure that the engine has adequately reduced its speed before downshifting to a lower gear.

Fuel and Oil system



WARNING

Gasoline is highly flammable and explosive under certain conditions.

- Always exercise extreme caution whenever handling gasoline.
- Always refuel with the engine stopped, and outdoors or in a well ventilated area.
- Do not smoke or allow open flames or sparks in or near the area where refueling is performed or where gasoline is stored.
- Do not overfill the tank. Do not fill the tank neck.
- If you get gasoline on your skin or clothing, immediately wash it off with soap and water and change clothing.
- Never start the engine or let it run in an enclosed area. Gasoline powered engine exhaust fumes are poisonous and can cause loss of consciousness or death in a short time.
- Shut off fuel valve whenever the ATV is stored or parked.



WARNING

The engine exhaust from this product contains chemicals known, in certain quantities, to cause cancer, birth defects or other reproductive harm.

Fuel System

The fuel tank filler cap is located directly behind the handlebar. Refer to your owner's manual for tank capacity. Use regular unleaded gasoline.



Fuel valve

The fuel valve is installed under the left side of the middle plate.

OFF: For vehicle storage and whenever transporting. Always turn the lever to this position when the engine is not running.

ON: Normal riding is done with the lever in this position.

Fuel filter

The filter (fuel filter located between fuel tank and gasoline cutting fuel inlet) should be replaced by your dealer every 100 hours of operation or annually. Do not attempt to clean the fuel filter.

Oil System

The oil tank is located on the right side of the engine.

To check the oil:

1. Set machine on a level surface.
2. Start the engine and let it idle for 20-30 seconds.
3. Stop the engine, remove dipstick (1) and wipe dry with a clean cloth.
4. Put dipstick into the oil tank (do not screw in it), remove it and read the oil level.
5. Remove dipstick and check to see that the oil level is between the mark (2) and (3).

Add oil as indicated by the level on the Dipstick. Do not overfill.

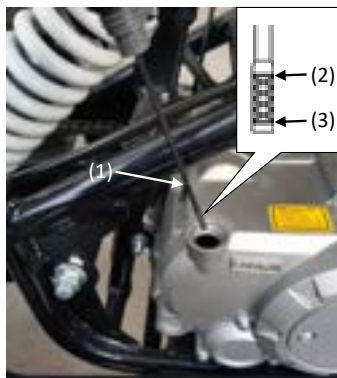

CAUTION

Use only 10W40 OIL.

Never substitute or mix oil brands. Serious engine damage and voiding of warranty can result.

Seat

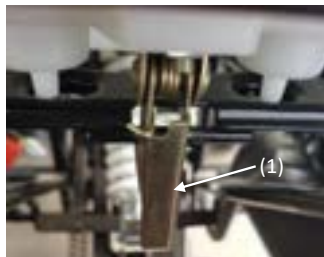

- 1) Pull the seat lock over(1) backwards, remove the seat.
- 2) When assembling the seat, making sure the limited block under the seat (2) be plugged into the limit slot of the frame(3), then pushing the seat forward and downward, until the seat is locked in.

8. STARTING THE ENGINE

Procedure for Starting a Cold Engine



WARNING

Never run an engine in an enclosed area. Carbon monoxide exhaust gas is poisonous and can cause severe injury or death. Always start engines outdoors.



CAUTION

You must allow your vehicle adequate warm up time before operating or engine damage could result.

1. Place the transmission in neutral and reset the parking brake.
 2. Turn the fuel tank valve to ON.
 3. Sit on the vehicle.
 4. Insert the key into the electric door lock, and spin to the "ON" position; open switch; seize the brake handle and press the power button to start.
 5. Do not press the throttle more than 20% while starting the engine.
 6. Activate the starter for a maximum of five seconds, releasing the button when the vehicle starts. If engine does not start, release the starter for another live seconds.
- Repeat this procedure until the engine starts.



CAUTION

This ATV is equipped with an electric start system. If the battery is under charging, the ATV will not run.

9. VEHICLE BREAK-IN PERIOD

The break-in period for your new ATV is defined as the first 20 hours of operation. No single action on your part is as important as a proper break-in period. Careful treatment of a new engine will result in more efficient performance and longer life for the engine. Perform the following procedures carefully.



CAUTION

Do not operate at full throttle or high speeds for extended periods during the break-in period. Excessive heat can build up and cause damage to close fitted engine parts.

Engine and Drive Train Break-in

1. Fill the fuel tank.
2. Check the oil reservoir level indicated on the dipstick. Add oil if necessary.
3. Drive slowly at first. Select an area which is open and will give you room to familiarize yourself with vehicle operation and handling.
4. Vary the throttle positions. Do not operate at sustained idle.
5. Perform regular checks on fluid levels, controls and all important areas on the vehicle as outlined earlier on the daily pre-ride inspection checklist found in "4. Daily pre-ride inspection".
6. Pull only light loads.

10. RIDING GEAR

Safe Riding Gear

Always wear clothing suited to the type of riding you are doing. ATV riding requires special protective clothing which will make you feel more comfortable and reduce chances of injury.

1. Helmet

Your helmet is the most important piece of protective gear for safe riding. A helmet can prevent a severe head injury.

2. Eye Protection

A pair of goggles or a helmet face shield offers the best protection for your eyes.

3. Gloves

Off-road style.

4. Boots

A pair of strong over-the-calf boots with heels, such as moto-cross boots.

5. Clothing

To protect your body, long sleeves and pants should always be worn. Riding pants with kneepads and a jersey with shoulder pads provide the best protection.

11. CARRYING LOADS

SYMOTOS ATV models has been designed to carry a certain amount of load. CARGO WEIGHT should be evenly distributed ($1/3$ on the front and $2/3$ on the rear) and mounted as low as possible. When operating over rough or hilly terrain, reduce speed and cargo weight to maintain stable driving conditions. Never exceed the weights specified in your Owner's Manual.

- Maximum load

Rear cargo rack:20kg (44lbs)

Front cargo rack:15kg (33lbs)

Improper loading of the front rack can obstruct the headlight beam, reducing night visibility. Do not obstruct the headlight beam with cargo.



WARNING

Correct loading of this vehicle is necessary to maintain proper stability and operating characteristics. Overloading or incorrect positioning of the load affects the vehicle's turning, stopping distance and stability. Failure to follow loading requirements could cause severe injury or death.



Important Safeguards

To reduce risk of injury or machine damage when carrying loads, read and follow the warnings listed below:

- **REDUCE SPEED AND ALLOW GREATER DISTANCES FOR BRAKING WHEN CARRYING CARGO.**
- **CARGO WEIGHT DISTRIBUTION** should be 1/3 on the front rack and 2/3 on the rear rack. When operating over rough or hilly terrain, reduce speed and cargo to maintain stable driving conditions. Carrying loads on one rack only increases the possibility of vehicle tipping over.
- **HEAVY LOADS CAN CAUSE BRAKING AND CONTROL PROBLEMS.**

Use extreme caution when applying brakes with a loaded vehicle. Avoid terrain or situations which may require backing downhill.

- **ALL LOADS MUST BE CARRIED AS LOW ON THE RACKS AS POSSIBLE.** Carrying loads high on the racks raises the center of gravity of the vehicle and creates a less stable operating condition. When cargo loads are carried high on the racks, the weight of the loads must be reduced to maintain stable operating conditions.
- **LOADS MUST BE CARRIED AS LOW ON THE RACKS AS POSSIBLE.**

Carrying loads high on the racks raises the center of gravity of the vehicle and creates a less stable operating condition. When cargo loads are carried high on the racks, the weight of the loads must be reduced to maintain stable operating conditions.

- **OPERATE ONLY WITH STABLE AND SAFELY ARRANGED LOADS.**

Avoid handling off-centered loads which cannot be centered.

- **EXTREME CAUTION MUST BE USED.** Avoid operating with loads extending over the rack sides. Stability and maneuverability may be adversely affected, causing the vehicle to overturn.
- **DO NOT BLOCK THE HEADLIGHT/TAILLIGHT AND THE REFLECTORS** when carrying loads on the racks.
- **DO NOT TRAVEL FASTER THAN THE RECOMMENDED SPEEDS.**

Vehicle should never exceed 10 mph (16 km/h) while towing a load on a level grass surface. Vehicle speed should never exceed 5 mph (8 km/h) when towing loads in rough terrain, while cornering, or while ascending or descending a hill.

12. RIDING



WARNING

You must inspect your ATV each time before riding to ensure it is in proper working order. If proper inspection is not done, severe injury or death could result.

See "4. DAILY PRE-RIDE INSPECTION"

1. Sit upright with both feet on footrests and both hands on the handlebars.
2. After starting the engine and allowing it to warm up, shift the transmission into gear.
3. Check your surroundings and determine your path of travel.
4. Release the parking brake.
5. Slowly depress the throttle with your right thumb and begin driving. Vehicle speed is controlled by the amount of throttle opening.
6. Drive slowly, practice maneuvering and using the throttle and brakes on level surfaces.

Making Turns

Practice making turns at slow speeds.

This ATV is equipped with a solid rear axle which drives both rear wheels equally at all times. This means that the wheel on the outside of the turn must travel a greater distance than the inside wheels when turning and the inside tire must slip traction slightly. To turn, steer in the direction of the turn, leaning your weight on the outer footrest. This technique alters the balance of traction between the rear wheels, allowing the turn to be made smoothly. The same leaning technique should be used for turning in reverse.



WARNING

Avoid turning at sharp angles in reverse as tip over and severe injury may result.

Riding on slippery surfaces.

When riding on slippery surfaces like wet trails, loose gravel, or in cold freezing weather, it is crucial to exercise extra caution to prevent the possibility of a vehicle overturn

Always:

1. Slow down when entering slippery areas.
2. Maintain a high level of alertness, continuously assess the trail conditions, and avoid making sudden, sharp turns that could lead to skidding.
3. Correct a skid by turning the handlebars in the direction of the skid and shifting your body weight forward.
4. Under no circumstances should you apply the brakes during a skid, as it can lead to a complete loss of control over the ATV.
5. Do not operate on excessively slippery surfaces.
6. Always reduce speed and use additional caution.



WARNING

Failure to exercise care when operating the ATV on slippery surfaces can be dangerous.

Loss of tire traction and vehicle control can result in an accident, including an overturn.

Traveling Uphill



WARNING

Exercise extreme caution when traveling in hilly terrain. Braking and handling are greatly affected. Loss of vehicle control or overturning of the ATV could occur causing severe injury or death.

Whenever traveling uphill always travel straight uphill and:

1. Avoid steep hills (15° maximum).
2. Keep both feet on the footrests.
3. Transfer your weight forward.
4. Proceed at a steady rate of speed and throttle opening.
5. Remain alert and be prepared to take emergency action. This may include quick dismounting of the ATV.



Side hilling

Side hilling is one of the most dangerous types of riding your ATV and should be avoided. If you do enter into a situation where side hilling is necessary, always:

1. Slow down.
2. Lean into the hill, transferring your upper body weight toward the hill while keeping your feet on the footrests.
3. Steer slightly into the hill to maintain vehicle directions.

If the vehicle begins to tip, quickly turn the front wheel downhill, if possible, or dismount on the uphill side immediately!



WARNING

Improperly crossing hills or turning on hills can be dangerous. Loss of vehicle control or overturning of the ATV could occur causing severe injury or death.

Traveling Downhill

Whenever descending a hill, always:

1. Drive directly downhill.
2. Transfer your weight to the rear of the vehicle.
3. Slow down.
4. Apply the brakes slightly to aid in slowing.



WARNING

Do not travel at excessive speeds. It is dangerous and can cause loss of vehicle control and tipping, resulting in severe injury or death.



Turning Around on a Hill

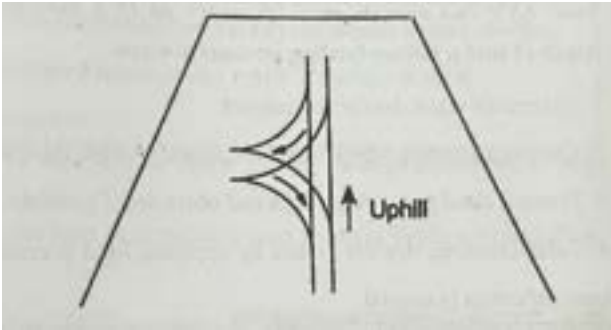

If the ATV stalls while climbing a hill, never back it down the hill! One maneuver which can be used when it is necessary to turn around while climbing a hill is the K-turn.

1. Stop and lock the parking brake while maintaining body weight uphill.
2. Leave transmission in forward and shut off the engine.
3. Dismount on the left or the uphill side of the ATV.
4. Staying uphill of the ATV, turn handlebars full left (while facing front of ATV).
5. While holding the service brake, release parking brake lock and slowly allow the ATV to roll around to your right until the ATV is pointing across the hill or slightly downward.
6. Lock the parking brake and remount the ATV from the uphill side, maintaining body weight uphill.
7. Restart engine with transmission still in forward, release parking brake, and proceed slowly, controlling speed with the service brake, until the ATV is on reasonably level ground.



WARNING

Avoid climbing steep hills. Loss of vehicle control or overturning of the ATV could occur resulting in severe injury or death.

Crossing Streams

Your ATV can operate through water up to a maximum recommended depth (8 inch). Before fording streams always:

1. Determine water depths and current.
2. Choose a crossing where both banks have gradual inclines.
3. Proceed slowly, avoiding rocks and obstacles if possible.
4. After crossing, dry the brakes by applying light pressure to the lever until braking action is normal.



CAUTION

Never operating the ATV through deep or fast flowing water.

NOTE: After running the vehicle in water, it is critical your machine is serviced as outlined in the maintenance chart see "**15. Maintenance**". The following areas need special attention: engine oil, and all grease fittings.

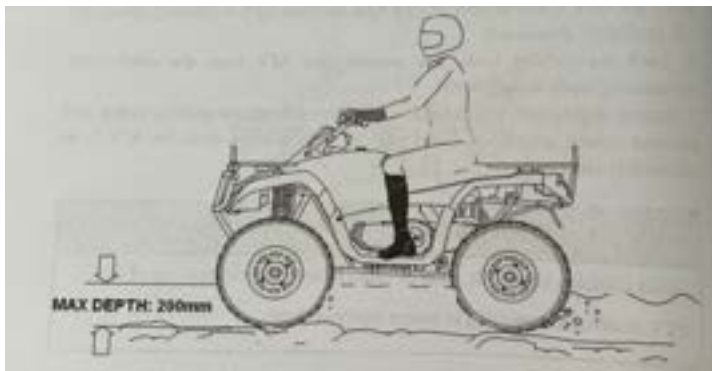



CAUTION

If your ATV becomes immersed, take it to your dealer before starting the engine. Major engine damage can result if the machining is not thoroughly inspected.

If it is impossible to take it to a dealer before starting, follow these steps outlined below.

- Move the ATV to dry land or at the very least, to water depth not more than 8 in.(200 mm).
- Turn the fuel valve to "OFF".
- Remove the spark plug.
- Loosen the carburetor drain screw (1)
- Turn the engine over several times with the electric start.
- Dry the spark plug and reinstall or replace it with a new plug.
- Tighten the carburetor drain screw (1).
- Turn the fuel valve to "ON".

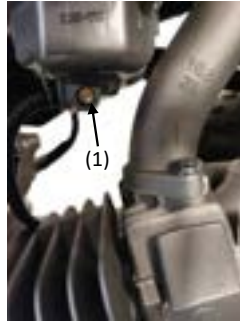

- Attempt to start the engine. If necessary, repeat the drying procedure.
- Take the machine to your dealer for service as soon as possible, whether you succeed in starting it or not.

Trail Obstacles

Keep Alert!

Look ahead and learn to read the trail as you ride. Stay on the right side of the trail, if possible, and be constantly alert for hazards such as logs, rocks and low hanging branches.



WARNING

Not all obstacles are visible. Travel with caution on trails. Severe injury or death can occur when vehicle comes in contact with a hidden obstacle.





WARNING

Backing your ATV can be dangerous!

You should hit an obstacle or a person behind you; or the vehicle could tip over rearward on a steep incline causing severe injury or death.

Backing up

1. Avoid backing up on steep inclines.
2. Always back slowly.
3. When in reverse, apply the brakes lightly for stopping.
4. Avoid turning at sharp angles in reverse.
5. Never open the throttle suddenly while backing.

NOTE: This ATV is equipped with a reverse speed limiter. Do not operate at wide open throttle. Only open the throttle enough to maintain a desired speed.



CAUTION

Opening the throttle more than required may cause excessive fuel to build in the exhaust, resulting in engine popping and/or engine damage.



Parking on an incline

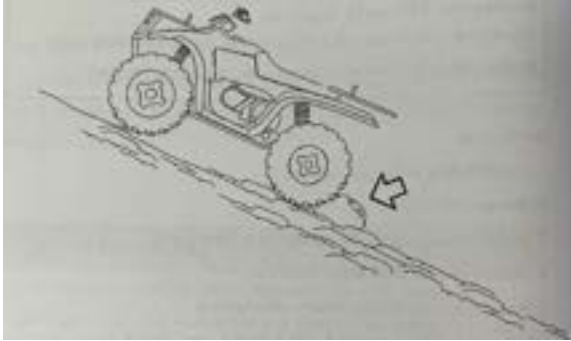

Whenever the vehicle is parked:

1. Turn the engine off.
2. Place the transmission in gear.
3. Set the parking brake.
4. Shut off fuel supply.
5. Avoid parking on an incline. If it is necessary to park on an incline, always block the rear wheels on the downhill side as shown above.
6. Do not leave the ATV on a hill depending on the parking brake for more than five minutes.

13. BATTERY

Battery



WARNING

Whenever removing the battery, disconnect the negative (-) cable first. When reinstalling the battery, connect the negative (-) cable last or explosive situation could result causing serious injury or death.



WARNING

Battery electrolyte is poisonous. It contains sulfuric acid. Serious burns can result from contact with skin, eyes or clothing.

Antidote:

External: Flush with water.

Internal: Drink large quantities of water or milk. Follow with milk of magnesia, beaten egg, or vegetable oil. Call physician immediately.

Eyes: Flush with water for 15minutes and get prompt medical attention.

Batteries produce explosive gases. Keep sparks, flame, cigarettes, etc. away. Ventilate when charging or using in an enclosed space. Always shield eyes when working near batteries. KEEP OUT OF REACH OF CHILDREN.



CAUTION

The battery is a disposable, maintenance-free unit. During its initial use, it's essential to adhere to the specified requirements for adding battery fluid. However, after this initial setup, there is no need to regularly check the electrolyte or distilled water levels. In the event of any battery issues, please contact your dealer for charging or replacement.

Battery Removal

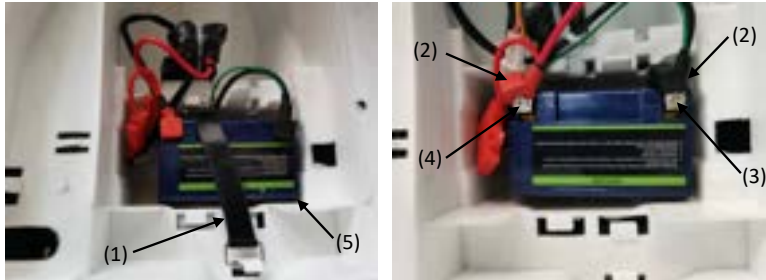

1. Make sure the main switch is off.
2. Remove the battery belt (1).
3. Remove the terminal lead cover (2).
4. Disconnect the negative (-) terminal lead (3) from the battery first, then disconnect the positive (+) terminal lead (4).
5. Remove the battery(5).

Battery Installation and Connections



WARNING

To avoid the possibility of explosion, always connect battery cables in the order specified. Positive (+) cable first; negative (-) cable last.
An exploding battery can cause serious injury or death.

Battery terminals and connections should be kept free of corrosion. If cleaning is necessary, remove the corrosion with a stiff wire brush. Wash with a solution of one tablespoon baking soda and one cup water. Rinse well with tap water and dry off with clean rags. Coat the terminals with dielectric grease or petroleum jelly. Be careful not to allow cleaning solution or tap water into the battery.

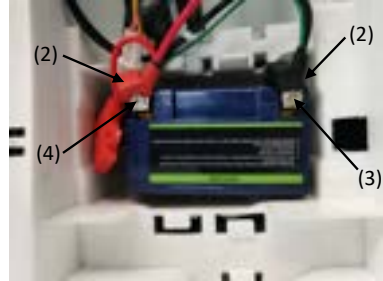
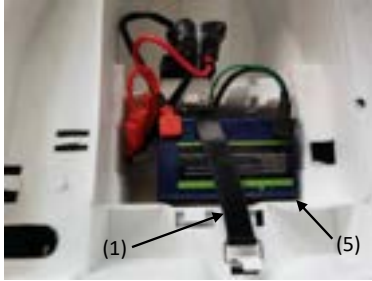

1. Set the battery (5) in its holder.
2. First connect and tighten the positive (+) cable (4).
3. Second connect and tighten the negative (-) cable (3).
4. Put on the terminal lead cover (2).
5. Put on the battery belt (1).
6. Verify that cables are properly routed.

NOTE:

- When your ATV is placed in storage for one month or more, the battery should be removed, charged to proper level, and stored in a cool dry place.
- Before reusing, take the battery to your dealer for testing and recharging
- When installing a new battery, make certain it is fully charged prior to its initial use. Using a new battery that has not been fully charged can damage the battery resulting in a shorter life of the battery; it can also hinder vehicle performance.



CAUTION

Your ATV's power supply may not be adequate to support optional equipment. Therefore, when installing any additional accessories or optional equipment, it is essential to upgrade your battery if required. Please consult your dealer to ensure you have the appropriate battery for your specific needs.

14. EXHAUST SYSTEM

System Regulation

TAMPERING WITH NOISE CONTROL SYSTEM PROHIBITED!

CAUTION: Exhaust system components are very hot during and after use of ATV.

- Do not touch exhaust system components. Serious burns can result.
- Be especially careful when traveling through tall grass. The potential for fire exists.

Spark Arrester

The exhaust pipe must be periodically purged of accumulated carbon as follows:

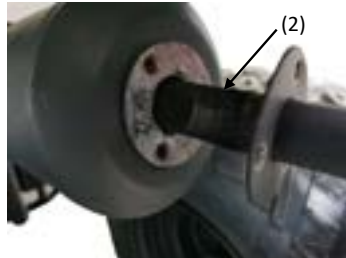
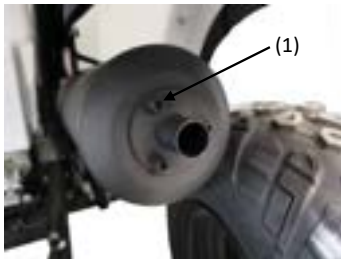

1. Remove the arrester screw (1) located on the bottom of the muffler, pull out the arrester (2).
2. Clean the arrester (2) or replace it.



WARNING

When cleaning the spark arrester, you must follow the safe guards listed below to avoid serious injury.

- Do not perform this operation immediately after the engine has been run because the exhaust system becomes very hot.
- Keep combustible materials away from exhaust system. Fire may result.

15. MAINTENANCE



CAUTION

More often under severe use, such as dirty or wet conditions to purge water or dirt contamination from grease fittings and other critical components.

Periodic Maintenance Schedule

Careful periodic maintenance will help keep your vehicle in the safest, most reliable condition. Inspection, adjustment and lubrication intervals of important components are explained in the following chart on the following pages.

Maintenance intervals are based upon average riding conditions and an average vehicle speed of approximately 10 miles per hour. Vehicles subjected to severe use, such as operation in wet or dusty areas, should be inspected and serviced more frequently.

Inspect, clean, lubricate, adjust or replace parts as necessary.

NOTE: Inspection may reveal the need for replacement parts. Always use genuine parts available from your dealer.

Service and adjustment are critical. If you are not familiar with safe service and adjustment procedures, have a qualified dealer perform these operations.

FOR THE VEHICLE

To keep the performance good, the motorcycle should be checked and maintained at certain interval. The meanings of capital in following table are:

I: Inspection, including check, clean, lubricate, refuel, repair or replacing if necessary.

A: Adjusting C: Cleaning R: Replacing T: Tightening L: Lubrication

Items	Maintenance period	Odometer (km)						Everyday check before riding
	500	3000	6000	9000	12000	15000		
**Re-seating Valve		I	I	I	I	I		
**Spark Plug		I	R	I	R	I		
**Fuel System	I	I	I	I	I	I	I	
*Engine Oil	R	R	R	R	R	R	I	
*Valve Gap		I	I	I	I	I		
*Idle Speed		I	I	I	I	I		
*Engine Bolt		I	I	I	I	I		
*Oil Filter		C	C	R	C	C		
*Fuel Filter		I	I	I	R	I		
*Air Cleaner		C	C	C	R	C		
*Drive Chain	IL	IL	IL	IL	IL	IL	I	
Engine Mount		I	I	I	I	I		
Fuel Line		I	I	I	I	I		
Throttle Operation		I	I	I	I	I		
Brake Shoes/Pad Wear		I	I	I	I	I		
Brake System		I	I	I	I	I	I	
Brake Light Switch	I	I	I	I	I	I		
Brake Liquid		I	I	I	I	I		
Clutch		I	I	I	I	I		
Suspension		I	I	I	I	I		
Nuts, Bolts, Fasteners		I	I	I	I	I		
Wheel/Tyre		I	I	I	I	I	I	
Steering System		I	I	I	I	I		

Lubrication Recommendations

	Item	Lube Rec	Method	Frequency
	1.Engine Oil	See"7 oil system"	Add to proper level on dipstick	Check Pre-Ride
	2.Brake Fluid	DOT 3 Only	Maintain level between fill lines. See "7.COMTROL"	As required;change every two years
●	3.Front A-arm Pivot Shaft	Grease	Locate fitting on pivot shaft and grease with grease gun	Every 3 months or 50 hours
●	4.Steering Post Bushing	Grease	Locate fitting on pivot shaft and grease with grease gun	Every 3 months or 50 hours
●	5.Front Wheel Bearing	Grease	Inspect and replace bearings if necessary	Semi-annually
	6.Tie Rods	Grease	Locate fittings and grease	Semi-annually
●	7.Rear Axle Bearing	Grease	Locate fittings and grease	Every 3 months or 50 hours
●	8.Swing Arm Bearing	Grease	Locate fittings and grease	Monthly or 20 hours
●	9.Throttle Cable	Grease M	Grease, inspect and replace it if necessary	Monthly or 20 hours

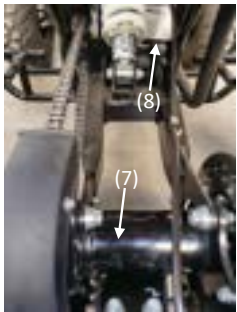
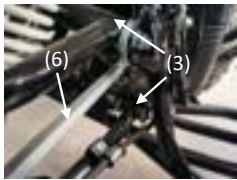

NOTE:

1. More often under severe use, such as wet or dusty conditions.
2. Grease: Light weight lithium-soap grease.
3. Grease M: molybdenum disulfide(MoS_2) grease(water resistant).
4. " ● " When suspension action becomes stiff or after washing.
5. Hours are based on 10 mph (16 Km/h) average.

Periodic Maintenance Record

Use the following chart to record periodic maintenance work:

Maintenance Interval Performed	KM (MILES)	Servicing Date	Servicing Dealer or Person	Remark
Initial 1 month				
2 month				
3 month				
4 month				
5 month				
6 month				
7 month				
8 month				

Handlebar Adjustment



WARNING

Improper adjustment of the handlebars or incorrect torquing of the adjuster block tightening bolts can cause limited steering or loosening of the handlebars, resulting in loss of control and possible serious personal injury or death.

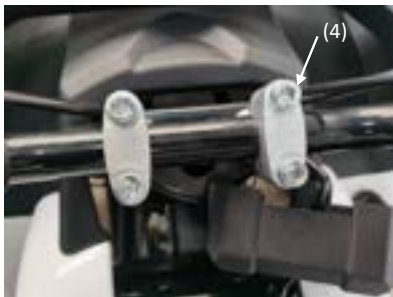
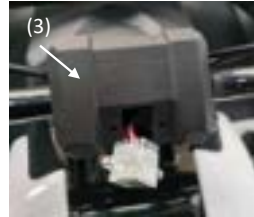

Your ATV has handlebars which can be adjusted for your personal fit.

1. Remove the ties (1).
2. Loosen the two bolts (2).
3. Remove the handlebar cover (3).
4. Loosen the four bolts (4).
5. Adjust handlebar to desired height. Be sure handlebars do not hit gas tank or any other part of machine when turned fully to left or right.
6. Torque handlebar adjuster block to 10-12 ft. lbs. (14-16 Nm).
7. After the handlebar is adjusted, the disassembled parts are reassembled.

NOTE: Tighten bolts so there is an equal gap at the front and rear of the handlebar block. Improper gap will result in improper fit of upper pod.

The following items should be checked occasionally for tightness; or if they have been loosened for maintenance service.

Wheel Nut Torque Specifications

Bolt Size	Specification	
M8X1.0	22 ft. lbs.	30 Nm
M10X1.25	33 ft. lbs.	45 Nm

NOTE: All nuts that have a cotter pin installed must be serviced by an authorized Dealer.

Front Wheel Hub Tightening

Front wheel bearing tightness and spindle nut retention are critical component operations. Service work must be performed by an authorized dealer.

Rear Spring Adjustment

The rear shock absorber spring is adjusted by rotating the adjuster (1) either clockwise or counterclockwise to increase or decrease spring tension. (Some models are not adjustable shock absorbers)



NOTE: Accessory springs are available through your SYMOTOS dealer.

Steering Inspection

The steering assembly of the machine should be checked periodically for loose nuts and bolts. If loose nuts and bolts are found, have your dealer tighten them before riding your vehicle.

Camber and Caster

Camber and caster can not be changed by yourself.



WARNING

Do not attempt to adjust the tie rod for toe alignment. Severe injury or death can result from improper adjustment. Contact your dealer. He/She has the training and tools to make these adjustments.

Front Brake



WARNING

Once a bottle of brake fluid is opened, use what is necessary and discard the rest. Do not store or use a partial bottle fluid. Brake fluid is hygroscopic, meaning it rapidly absorbs moisture from the air. This causes the boiling temperature of the brake fluid to drop, which can lead to early brake fade and the possibility of serious injury.

Front brakes are disc brakes, which controlled by a small brake lever on the right side of the handlebar.

The following checks are recommended to keep the brake system in good operating condition. How often they need checking depends upon the type of driving that has been done.

- Keep fluid level in the master cylinder reservoirs as described see "7.Control and parts functions". Normal functioning of the diaphragm is to extend into the reservoir as fluid level drops. If the fluid level is low and the diaphragm is not extended, a leak is indicated and the diaphragm should be replaced. Always fill the reservoir as indicated whenever the cover is loosened or removed to insure proper diaphragm operation. Use DOT 3 brake fluid.

- Check brake system for fluid leaks.
- Check brake for excessive travel or spongy feel.
- Check friction pads for wear, damage and loosened.
- Check security and surface condition of the disc.
- Pads should be changed when friction material (A) is worn to $3/64"$ (1mm).

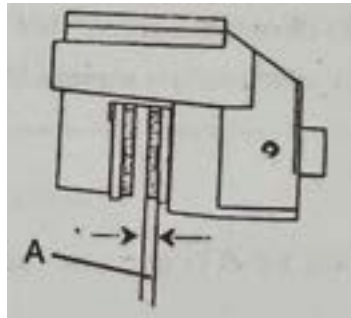

Rear brake

Rear brake is a hydraulic brake, which controlled by a small brake on the left side of the handlebar.

The following checks are recommended to keep the brake system in good operating condition. How often they need checking depends upon the type of driving that has been done.

- Keep fluid level in the master cylinder reservoirs as described see "7. Control and parts functions". Normal functioning of the diaphragm is to extend into the reservoir as fluid level drops. If the fluid level is low and the diaphragm is not extended, a leak is indicated and the diaphragm should be replaced. Always fill the reservoir as indicated whenever the cover is loosened or removed to insure proper diaphragm operation. Use DOT 3 brake fluid.

- Check brake system for fluid leaks.
- Check brake for excessive travel or spongy feel.
- Check friction pads for wear, damage and loosened.
- Check security and surface condition of the disc.
- Pads should be changed when friction material(A) is worn to 3/64" (1 mm).

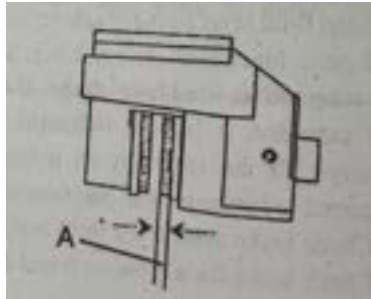

Spark Plugs

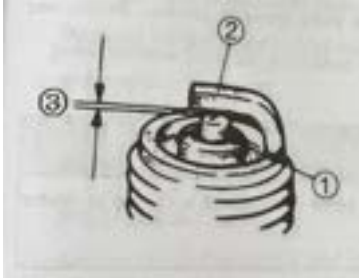

Standard spark plug
A7RTC (TORCH)

Inspect:

- Insulator ①
- Abnormal color: Replace.
- Normal color is a medium-to-light tan color
- Electrode ②
- Wear/damage: Replace.

Clean:

- Spark plug
(with spark plug cleaner or wire brush)

Measure:

- Spark plug gap ③
- Out of specification: Adjust gap.

Spark Plug Removal and Replacement



WARNING

Never attempt to remove a spark plug while the engine is warm. The exhaust system or engine could burn you causing severe injury.

Remove the spark plug by rotating counterclockwise.

Reverse the procedure for spark plug installation. Torque to 17 ft. lbs. (23 Nm)

Engine Oil Change

NOTE: Severe use operation requires more frequent service. Severe use includes continuous duty in dusty or wet conditions, and cold weather riding.



CAUTION

Oil may be hot. Do not allow hot oil to come into contact with skin as severe burns may result.

Engine oil replacement



(1) Oil fill cap

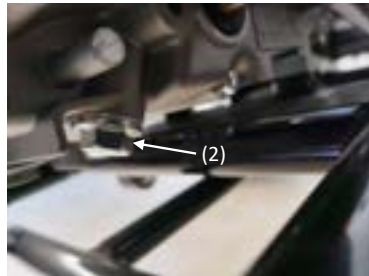

(2) Drain plug

- A. Place the machine on a level place.
- B. Warm up the engine for several minutes and stop it.
- C. Place a container under the engine.
- D. Remove the oil fill cap (1) and drain plug (2) to drain the oil.
- E. Reinstall the drain plug and tighten the drain plug to specification.
- F. Fill the engine oil and install the oil fill cap.



CAUTION

Be sure no foreign material enters the crank case.

Recommended oil and oil quantity according to the chart found in "17.

SPECIFICATION/Engine"

Engine oil level measurement

- A. Place the machine on a level place.
- B. Warm up the engine for several minutes and stop it.
- C. Remove the dipstick (1) and wipe it off with a clean rag. Insert the dipstick in the filler hole without screwing it in.
- D. Remove the dipstick and inspect the oil level.
- E. The oil level should be between the maximum (2) and minimum marks (3). If the level is low, add oil to raise it to the proper level.

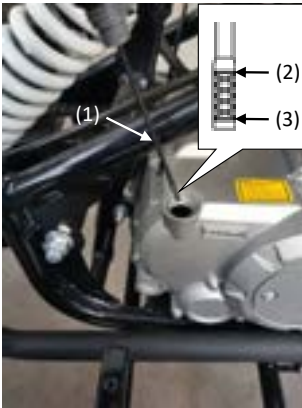

- (1) Dipstick/oil filler cap (2) Maximum level mark (3) Minimum level mark



CAUTION

Be sure no foreign material enters the crank case.

Wheel



WARNING

Operating your ATV with worn tires, improperly inflated tires, non-standard tires or improperly installed tire will affect vehicle handling which could cause an accident resulting in serious injury or death.

Follow the safeguards listed below to prevent this type of situation.

Important Safeguards

Maintain proper tire pressure. Improper tire inflation may affect ATV maneuverability.

Do not use improper tires. The use of non-standard size or type tires may affect ATV handling.

Make certain the wheels are installed properly. If wheels are improperly installed it could affect vehicle handling and tire wear.

Wheel Removal Procedure

1. Stop the engine, place the transmission in gear and lock the parking brake.
2. Loosen the wheel nuts slightly.
3. Elevate the side of the vehicle by placing a suitable stand under the footrest frame.
4. Remove the wheel nuts and remove the wheel.

Wheel Installation

1. With the transmission in gear and the parking brake locked, place the wheel in the correct position on the wheel hub. Be sure the valve stem is toward the outside and rotation arrows on the tire point toward rotation.
2. Attach the wheel nuts and finger tighten them.
3. Lower the vehicle to the ground.
4. Securely tighten the wheel nuts according to the chart found in "15. MAINTENANCE/Wheel Nut Torque Specifications".

Tire Inspection

When replacing a tire always use original equipment size and type according to the chart found in "**17. SPECIFICATION/Drive system**".

Tire Tread Depth

Always replace tires when tread depth is worn to 1/8"(3mm)(1) or less. Please refer to your Owner's Manual for tire specifications.

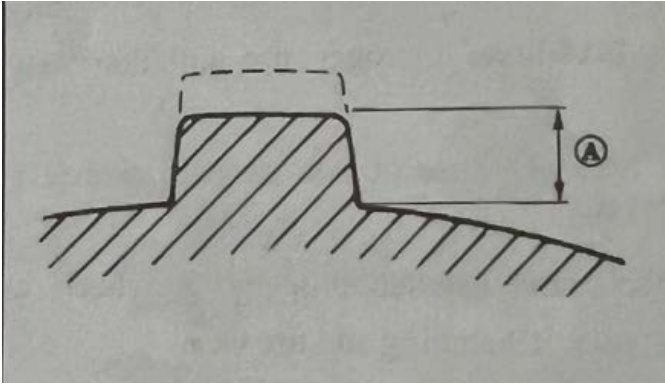

Headlight Lamp Replacement



WARNING

Keep your headlights and taillights clean. Poor light while riding can result in an accident causing severe injury or death.

Air Filter Cleaning

The air cleaner accumulates dust and must be cleaned periodically. If the ATV is ridden in dusty areas, the air cleaner must be cleaned at more frequent intervals than specified in the Maintenance Schedule. If the ATV is submerged in water, the air cleaner should be checked and water should be drained from the air cleaner housing before starting the engine.

To clean the air cleaner:

1. The air cleaner (1) is in the middle of the engine and the tank.
2. Loosen the screw (2) and clamp (3).
3. Loosen the screw (4) and clamp (5).
4. Remove the air cleaner from the ATV.
5. Unhook the clamp (6).
6. Unhook the holder (7) holding the air cleaner, and then pull out the paper material (8) from the air cleaner.
7. With a clean soft brush along the fold of the filter to brush off the surface of the dust, and then use the method of vibration to remove the dust inside the filter.
8. Check the paper material and replace it if damaged.
9. Reassemble by reversing the disassembly sequence.

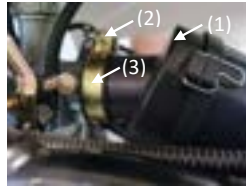

(1)Air cleaner (2)Screw (3)Clamp



(4)Screw (5)Clamp

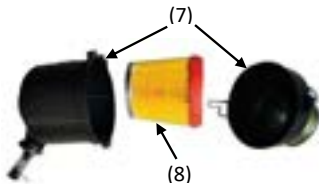

(7) Holder (8)Paper material



(6)Clamp

Drive Chain Slack Check

Inspect the drive chain while all tires are touching the ground. Check the slack at the position shown in the figure(A).

The normal vertical deflection is approximately 10- 20 mm (0.39- 0.79in). If the deflection exceeds 20 mm (0.79 in), adjust the chain slack.



Drive chain slack adjustment

1. Loosen the upper and lower axle holding bolts(1).
2. Turn the adjusting nut (2), to decrease or increase chain slack.
3. Retighten the upper and lower axle holding bolts.

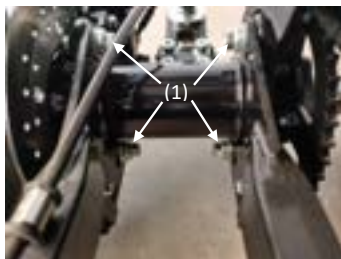

(1) Axle holding bolt X4



(2) Adjusting nut



CAUTION

Too little of chain slack will overload the engine and other important parts. Keep the slack within the specified limit.

Valve Gap Adjustment

The correct valve gap changes with use, resulting in improper fuel/air supply or engine noise. To prevent this, the valve gap must be adjusted regularly. This adjustment however, should be left to a professional SYMOTOS service technician.

Front And Rear Brake Pads Inspection

A wear indicator is provided on each brake. The indicators allows checking of brake pads wear. Check the position of the indicator. If the indicator reaches the wear limit line, ask a SYMOTOS dealer to replace the pads.

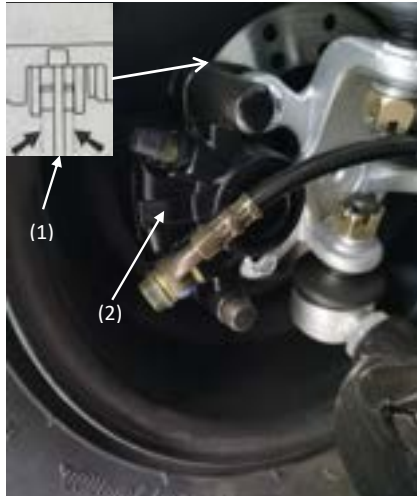

(1)Wear indicator (2) R/L Front brake

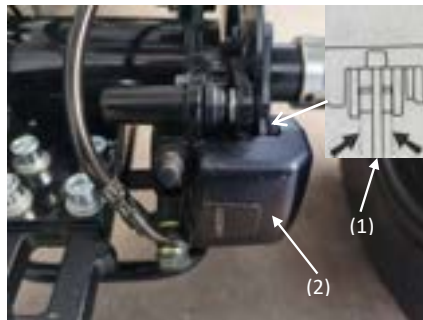

(1) Wear indicator (2) Rear brake

Cleaning Your ATV

Keeping your ATV clean will extend the life of various components.

Washing

Never use a high pressure type car wash system, it can damage the wheel bearings, transmission seals, body panels, brakes and warning labels, and water might enter the engine or exhaust system.

The best and safest way to clean your ATV is with a garden hose and a pail of mild soap and water. Use a professional type washing mitten, cleaning the upper body first and lower parts last. Rinse with water frequently and dry with a chamois to prevent water spots.

NOTE: If warning labels are damaged, contact your dealer for replacement.

Waxing

Your ATV can be waxed with any non-abrasive automotive paste wax. Avoid the use of harsh cleaners since they can scratch the body finish.



CAUTION

Certain products, including insect repellants and chemicals, will damage plastic surfaces. Care must be taken when using these products.

Storage Tips



CAUTION

Do not start the engine during the storage period. This will disturb the protective film created by fogging.

Cleaning--Clean the ATV thoroughly.

Fuel -Turn the fuel valve to "OFF" and drain the carburetor bowl completely.

Oil Add and Filter Change - Warm the engine and change oil and filter.

Air Filter/Air Box- Inspect and clean or replace the pre-cleaner and air filter. Clean the air box and drain the sediment tube.

Inspect All Fluid Levels- Inspect the following fluid levels and change if necessary: Engine Oil; brake fluid (change every two years or as required if fluid looks dark or contaminated).

Fog the Engine- Spray light oil into the cylinder through the spark plug hole.

Check and Lubricate Cables/Grease- Inspect all cables and lubricate.

Battery Maintenance-Remove the battery and add distilled water as required to the proper level. Do not use tap water which may contain minerals that reduce battery life. Apply dielectric Grease to the terminal bolts and terminals. Charge the battery.

Storage Area/Covers- Set tire pressure and safely support the ATV with the tires 1-2" (25-50mm) off the ground. Be sure the storage area is well ventilated. Cover the machine with an ATV cover.

NOTE: Do not use plastic or coated materials. They do not allow enough ventilation to prevent condensation, and may promote corrosion and oxidation.

Transporting

Whenever the ATV is to be transported, the following measures should be taken.

1. Turn off the engine and remove the key.
2. Turn the fuel valve to off.
3. Be certain the fuel cap, oil cap, and seat are installed correctly.
4. Always tie the frame of the ATV to the transporting until securely using suitable straps or rope.
5. Always place the transmission in gear and lock the parking brake.

16. TROUBLE SHOOTING

Battery Wane

Possible Causes	Solutions
Starting a faulty engine for a long time.	See "8. STARTING THE ENGINE" and check the fuel/air/ignition/compression system.
Let the main switch (key) on while parking the ATV.	When stopping the engine, turn off the main switch (key) off at once.



WARNING

This ATV is only equipped with an electric start system. If the battery is under charging, the ATV will not run.

NOTE:

The following troubleshooting does not cover all the possible causes of trouble. It should be helpful, however, as a guide to troubleshooting. Refer to the relative procedure in this manual for inspection, adjustment and replacement of parts. Adjustment and replacement must be done by your dealer.

STARTING FAILURE/HARD STARTING**FUEL SYSTEM****Fuel tank**

- Empty
- Clogged fuel tank breather hole
- Deteriorated fuel or fuel containing water or foreign material

Carburetor

- Deteriorated fuel or fuel containing water or foreign material
- Clogged pilot jet
- Clogged air passage
- Improperly set pilot air screw
- Clogged pilot air passage
- Improperly sealed valve seat
- Improperly adjusted fuel level
- Clogged starter jet
- Sucked-in air

Air cleaner

- Clogged air cleaner element
- Improper air cleaner setting

COMPRESSION SYSTEM

Cylinder and cylinder head

- Loose spark plug
- Loose cylinder head
- Broken cylinder head gasket
- Broken cylinder gasket
- Worn, damaged or seized cylinder

Piston and cylinder head

- Worn piston
- Worn, fatigued or broken piston ring
- Seized piston ring
- Seized or damaged piston

IGNITION SYSTEM

Battery

- Improperly charged battery
- Faulty battery

Fuse

- Burnt out, improper connection

Spark plug

- Improper plug gap
- Worn electrodes
- Wire between terminals broken
- Improper heat range
- Faulty spark plug cap

Ignition coil

- Broken or shorted primary/ secondary coil
- Faulty high tension cord
- Broken ignition coil body

Valve system

- Improperly adjusted valve clearance
- Improperly sealed valve
- Improperly contacted valve and valve seat
- Improper valve timing
- Broken valve spring
- Seized valve

Ignition system

- Faulty igniter unit
- Faulty pick up coil
- Broken magneto woodruff key

Switch

- Faulty main switch
- Faulty "ENGINE STOP" switch
- Faulty brake switch

Wiring

- Loose battery terminal
- Loose coupler connection
- Improperly grounded
- Broken wire harness

POOR IDLE SPEED PERFORMANCE

Carburetor

- Loose or clogged pilot jet
- Damaged carburetor joint
- Improperly tightened carburetor
- Joint clamp hose
- Improperly adjusted idle speed (Pilot screw), (Throttle stop screw)
- Improperly adjusted throttle cable
- Flooded carburetor

Air cleaner

- Clogged air cleaner element

Ignition system

- Fault spark plug
- Fault high tension cord
- Fault igniter unit
- Fault pick up coil
- Fault ignition coil

Valve system

- Improperly adjusted
- Valve clearance

POOR MEDIUM AND HIGH SPEED PERFORMANCE

Carburetor

- Improperly adjusted fuel level
- Clogged main nozzle
- Clogged or loose pilot jet

POOR SPEED PERFORMANCE

Ignition system

- Dirty spark plug
- Improper heat range
- Faulty igniter unit
- Faulty pick up coil

Fuel system

- Clogged fuel tank breather hole
- Clogged air cleaner element
- Clogged jet
- Improperly adjusted fuel level
- Improper carburetor air vent hose setting

Air cleaner

- Clogged air cleaner element

Compression system

- Worn cylinder
- Worn or seized piston ring
- Cylinder head gasket broken
- Cylinder gasket broken
- Carbon deposit build up
- Improperly adjusted valve clearance
- Improperly contacted valve and valve seat
- Faulty valve timing

Engine oil

- Improperly oil level (low or over oil level)

Ignition system

- Faulty spark plug
- Faulty high tension cord
- Faulty ignitor unit
- Faulty pick up coil
- Faulty ignition coil
- Valve system
- Improperly adjusted valve clearance

OVER HEATING**Ignition system**

- Improperly spark plug gap
- Improper spark plug heat rang
- Faulty ignitor unit

Fuel system

- Improper carburetor setting
- Clogged air cleaner element
- Improper fuel level adjustment

Compression system

- Heavy carbon deposit build-up
- Improperly adjusted valve clearance
- Improperly adjusted valve timing

Engine oil

- Incorrect engine oil level
- Improper engine oil quality (high viscosity)
- Low engine oil quality

Brakes

- Dragging brake

17. SPECIFICATION

Capacities		
Manufacturer Model Name	UT13	
Length(mm)	1740	
Width(mm)	970	
Height(mm)	990	
Seat height(mm)	700	
Wheel Base(mm)	1050	
Ground Clearance(mm)	145	
Curb Mass(Kg)	173	
Load Capacity(Kg)	255	
Fuel capacity(L)	4.5/6	
Engine Oil Capacity(ml)	800	
Drive System		
Front Tire	20×7-10	
Rear Tire	19×10-9	
Drive System	Chain drive	
Tire Pressure(front)	36psi (250kPa)	
Tire Pressure(rear)	36psi (250kPa)	
Service Brake	Front Brake	manual
	Rear Brake	manual
Parking Brake	Front Wheel	manual
	Rear Wheel	manual

Electrical Equipment	
Battery	12V/7Ah
Front light	Led/Bulb
Rear light	led
ENGINE	
Engine Type	1P56FMJ
Bore x Stroke	56×57
Displacement	140cc
Starter System	Power on
Engine Cooling	Wind/oil cooling
Lubrication System	Splash pressure lubrication
Carburetor Type	PZ27-1Le
Ignition Type	C.D.I Non-contact ignition
Spark Plug Type	A7RTC
EPA Code	
Fuel Tank	70502-013
Fuel Tank Cap	70502-009-A
Air Filter	11400-062
Exhaust Muffler	11500-015
Igniter	20301-022
Ignition Coil	20701-047-01

18. WIRING DIAGRAM

