

TARO | THE JOY OF RIDING





TARO

— THE JOY OF RIDING —

Zhejiang LEQI Vehicle Co.,Ltd.

Address:No.1288 Fangte Ave,East Taizhou Bay District,Taizhou City,Zhejiang Province.

 Tel:+86 576-8472 9972

 Fax:+86 576-8472 9977

 Email:[taromoto@taromoto.com](mailto:taromoto@taromoto.com)

 Web:[www.taromoto.com](http://www.taromoto.com)

A close-up, low-angle shot of a red motorcycle's front end. The focus is on the headlight assembly, which is partially illuminated, showing the internal lens and reflector. The surrounding fairings are a vibrant red, with highlights and shadows that emphasize their aerodynamic curves. The background is dark, making the red and the metallic parts of the headlight stand out.

**TARO D01**  
**OWNERS**  
**MANUAL**

**AC18**

**You have purchased a our scooter,  
Congratulations and thank you for putting  
your trust in us.**

This model is a sturdy scooter in modern design.

Its sound construction,the meticulous selection of materials,the advanced manufacturing techniques and conscientious work of dedicated employees provides the scooter with all the characteristics such as economical operation, quality,reliability and its lasting value.

## **PREFACE**

We cannot be held liable for any consequential damage caused by accessories not approved by the factory.

The scope of delivery and version of the scooter is solely determined by the purchase agreement concluded with the dealer

This operating manual includes important instructions for handling your light scooter read it carefully,because professional handling combined with regular care and maintenance helps to maintain the scooter's value and is one of the requirements for warranty claims.

We wish you at all times a safe journey

## **Safety symbols and notes**

**Please observe the following:**

### **WARNING**

Precautionary measures against the risk of accidents,injury and /or death.

### **FIRE HAZARD**

The vehicle is equipped with a catalyst,this results in extremely high temperatures on the exhaust system (risk of burning)

### **CAUTION**

Important instructions and precautionary rules to avoid damage to the vehicle. Nonobservance can lead to the warranty becoming void.

### **NOTE**

Special instructions for better handling during operation,inspection adjustments and service activities.

## 目录

VIN and Motor Serial Number .....	1
Right-hand side view .....	2
Left-hand side view.....	3
Dashboard Indicators.....	4
Ignition and fork-column lock .....	5
Storage box .....	6
Fuel, fuel tank .....	7
Fuel tank cap .....	8
Side stand and parking stand .....	9
Checklist.....	10
Load /lights .....	11
Correctly loaded .....	11
Ride safely.....	11
Ride economically and be aware of the environment.....	12
Running-in .....	13
Starting with the electric starter.....	14
Braking .....	15
Braking .....	16
Servicing the scooter / .....	17
cleaning agents .....	17
Servicing the scooter / cleaning agents .....	18
Repairing paint damage.....	19
Technical changes, accessories and spare parts.....	20
Engine oil.....	21
Checking the steering bearings .....	23
Tire profile.....	24

Cleaning and replacing the air filter.....	25
Checking the fuse.....	26
Battery.....	27
Removing and installing the battery.....	28
TR200T-5 Main technical parameters.....	29
TR200T-5 Main technical parameters.....	30
TR200T-5 Main technical parameters.....	31
TR200T-5 Main technical parameters.....	32
Warranty conditions.....	33
List of wear parts.....	34
List of trouble codes.....	37
List of trouble codes.....	39

## VIN and Motor Serial Number

Name plate

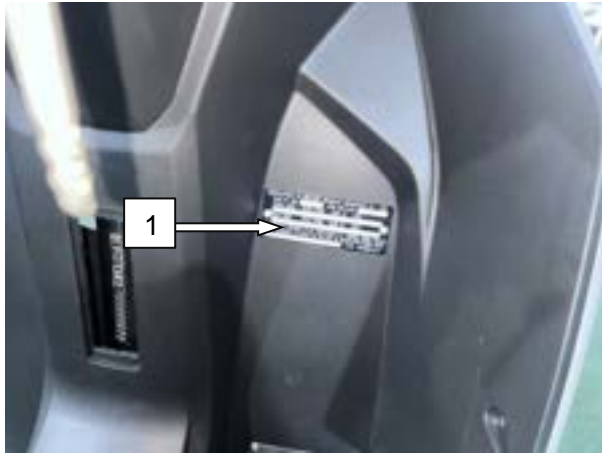

VIN

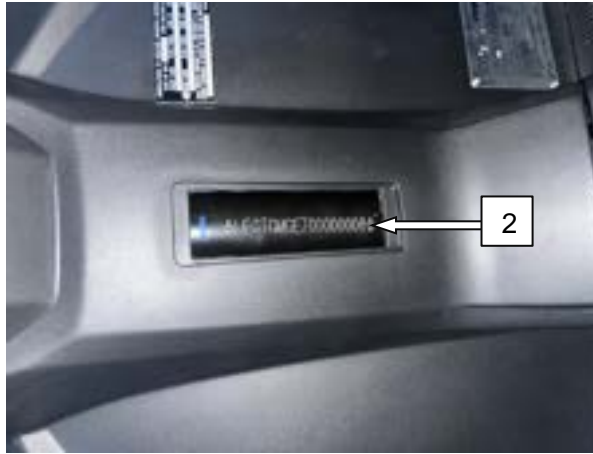

Engine number

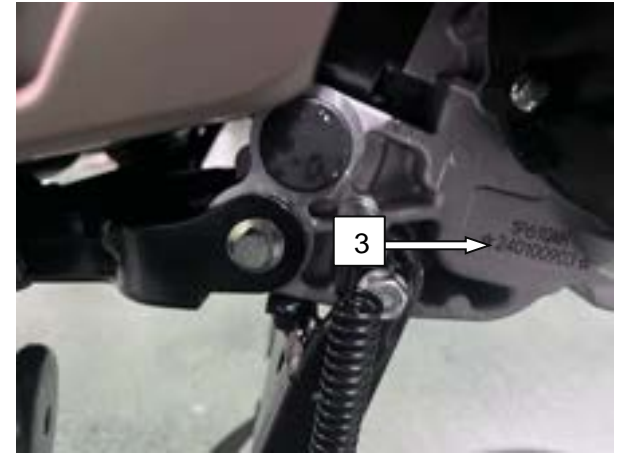

### NOTE

The description for right-hand side is viewed from the driver.

The name plate (1) is located on the right side of leg shield.

The VIN (2) is located inside the leg shield.

The engine number (3) is located in the lower part of the engine.

## Right-hand side view

- 1 Storage box with tool kit
- 2 Battery box and fuse (inside)
- 3 Ignition and fork-column lock
- 4 Brake fluid container for front wheel brake
- 5 Handbrake lever for front brake
- 6 Fan



## Left-hand side view

7 Handbrake lever for rear brake

8 The left handle bar

9 Transmission oil filler plug

10 Air filter

11 Side stand



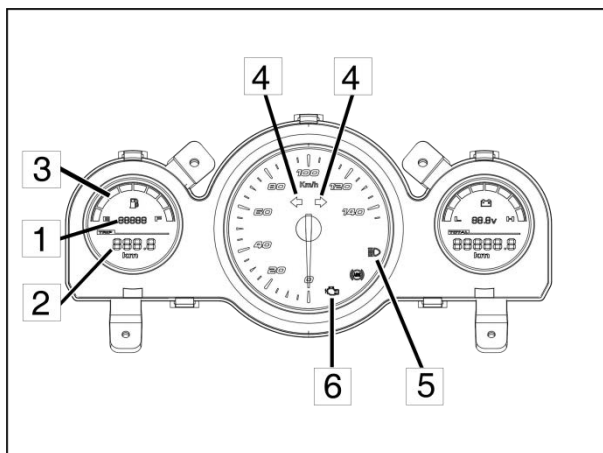

# Dashboard Indicators

## Instrument







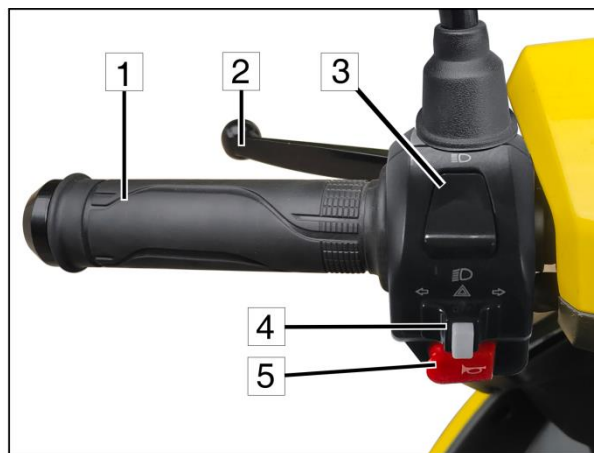

- 1 Speedometer km/h/mph
- 2 Odometer/Trip km/mile
- 3 Fuel indicator 
- 4 Date/Time

### Instrument lights

- 5 Left and right direction indicator  green
- 6 High beam indicator  Blue
- 7 EFI Indicator  orange



## Handlebar instrument, left

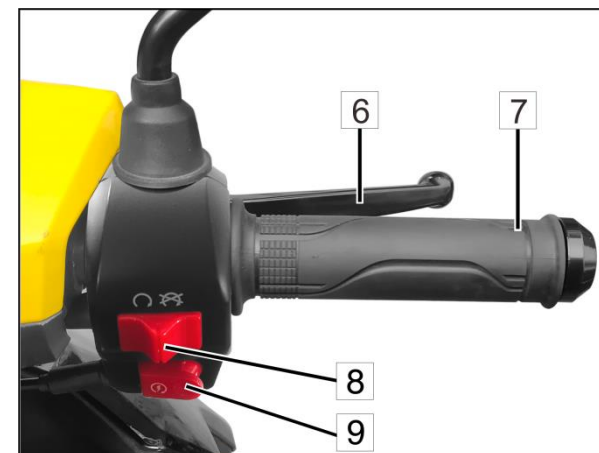

- 1 Fixed grip
- 2 Handbrake lever for rear brake
- 3 Headlamp dimmer switch
  -  high beam
  -  low beam
- 4 Direction indicator switch
  -  :Right turn signal
  -  :Left turn signal
- 5  horn button

## Handlebar instrument, right



- 6 Handbrake lever for front brake
- 7 Throttle grip
- 8 Engine off switch
  -  :The circuit is disconnected and the engine can not be started.
  -  :The circuit is closed and the engine can be started.
- 9  Start button

## Ignition and fork-column lock

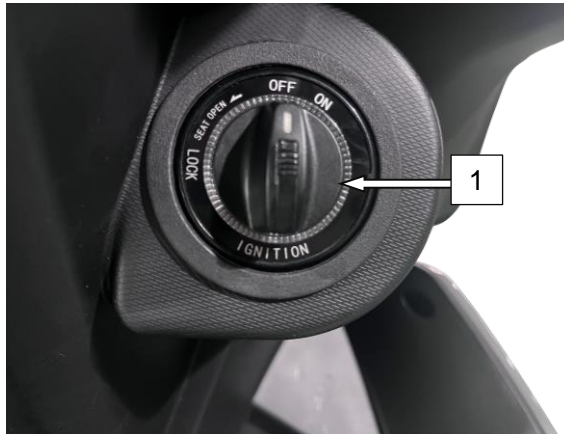

### **WARNING**

While riding, do not switch the ignition off  ” .

### **NOTE**

Keys

With the scooter you get two indefinite ignition keys. Keep the spare key at a safety place.

Key positions

### **NOTE**

Activate the parking light only for a limited period. Take into account the charge of the battery.



### **Two ignition methods:**

#### 1. Keyless ignition

Keyless start range: the remote lock is within 2 meters of an open area without interference. Press the knob on the lock of the Smart car, the indicator light is lighted, and the knob can be turned to drive;

2. Emergency Mechanical Lock Lift up the black cover on the front lock and insert the mechanical lock to rotate the front lock.

### **NOTE**

"OFF" It means that the whole circuit is open and the engine can not start.

"ON" It means the whole circuit is closed and the engine can start

### **NOTE**

Automatic fortification function  
When the head lock knob is changed from "ON" to "OFF", the host computer automatically enters the fortified state for 60 seconds without any operation. In this state, if the remote control lock is within the starting range, when the vibration signal is triggered, the host computer only enters the fortified state, but do not carry out the corresponding alarm, only the function of flashing lights; if beyond the starting range, when the vibration signal is triggered, the host only enter the fortification state, at the same time carry out the corresponding alarm.

## Storage box



- Do not store valuables in the box.
- Make sure that the seat has been locked completely after it was pressed down.
- Take out valuables before washing to avoid wet these objects.
- Do not place thermal sensitive objects in the box because of engine's heat and high temperature.

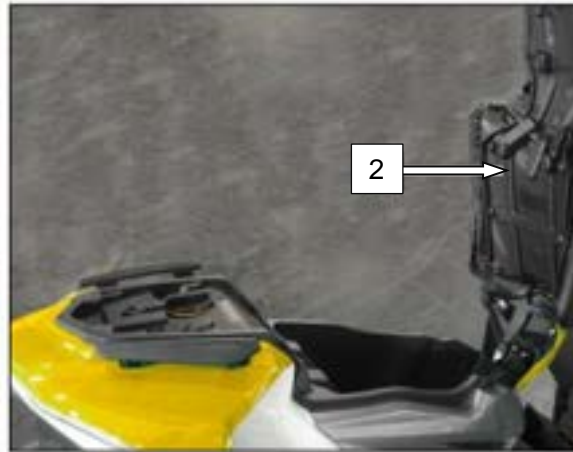

### Unlock

In the flue off state, press the knob(1) on the smart car lock and rotate to "SEAT OPEN" to unlock the SEAT(2) and open the SEAT(2).



### WARNING

After the seat is closed check if it was locked firmly!

-Risk of accidents!

Maximum load capacity: 10 kg

## Fuel, fuel tank

### **WARNING**

Fuel is highly inflammable and can explode. Do not smoke or bring a naked flame near the fuel tank.

Fuel expands under the influence of heat and the sun. Therefore, never fill the tank to the brim. Never fill the tank while the engine is running.

Never bring a glowing cigarette or naked flame near an open tank, because fuel vapour could suddenly ignite.

## Fuel stock, tanking

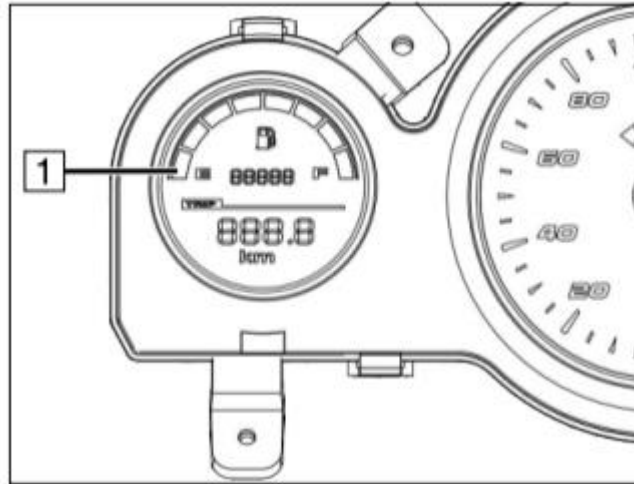

### **NOTE**

When fuel indicating scale (bottom) is flashing. It means, it is using spare fuel(around 1 L). Please fill the fuel accordingly.

The scale with the tank symbol  remembers for a tank stop.

**E=Empty**

**F=Full**

Don't urn down the fuel tank until it is empty

### **Filling up with fuel**

-Use only premium lead-free fuel (min.92 octane)

## Fuel tank cap



### Unlock:

- In the fuel off state, press the knob(1) on the smart car lock and rotate to "SEAT OPEN" to unlock the SEAT(2) and open the SEAT(2).
- The fuel tank is under the rear seat cushion.

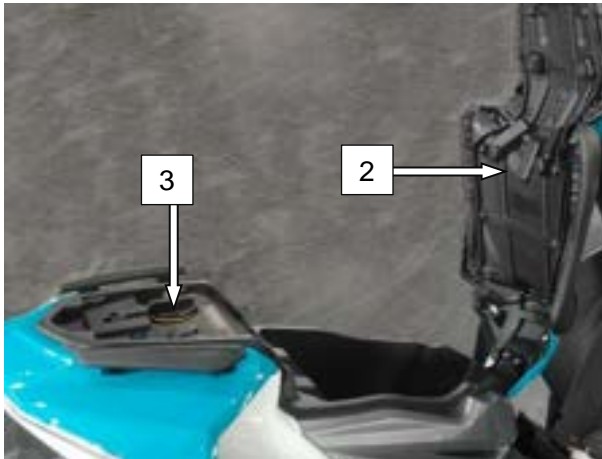

### LOCK:

- Align the tank cap (3) with the tank opening (4) and turn it clockwise.
- Close the seat cushion.(2).

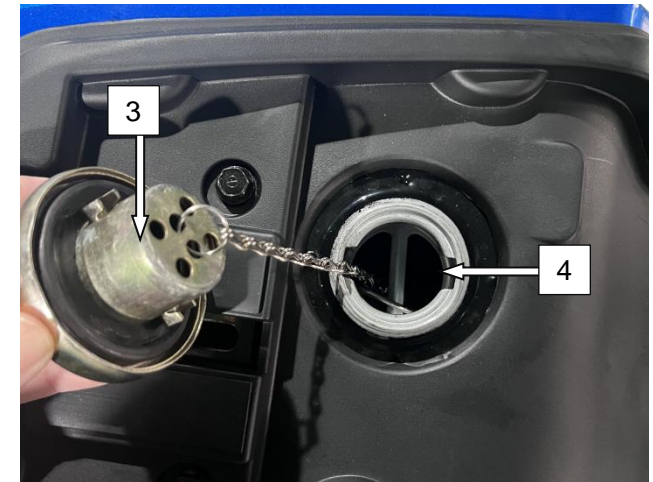

### NOTE

The tank cap is located at the front of the seat.

## Side stand and parking stand

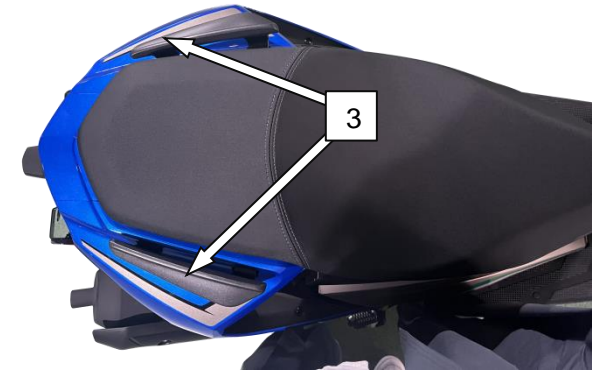
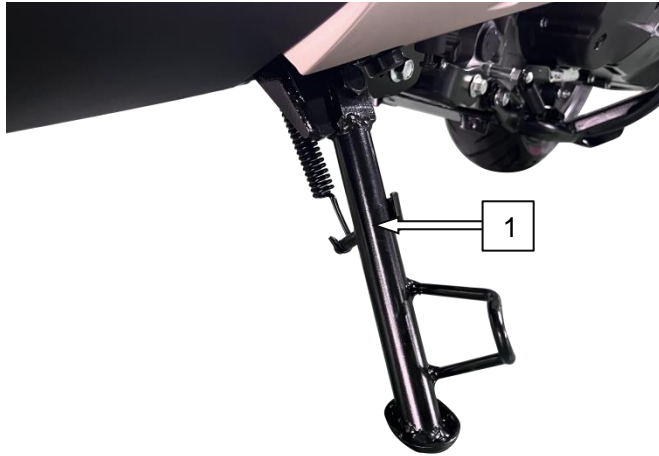

Propping up the scooter on the side stand.

### **WARNING**

Always make sure that the stand is resting on firm ground. On sloping roads, always park the scooter facing uphill.

It is essential that the side stand is folded up before starting off! -Risk of accident!

### **Side stand**

#### **NOTE**

The scooter is equipped with a side stand switch. If the side stand is folded up the engine is shut off and will not start.

- Switch off the engine
- Put your left hand on the left-hand handlebar grip.
- Hold with your right hand the holder grip (3).
- Fold out the arm for the side stand (1) as far forward as it will go and stop by foot.
- Slowly tilt the scooter to the left until its weight is supported.

### **Parking stand**

- Switch off the engine.
- Put your left hand on the left-hand handlebar grip.
- Hold the holder grip (3) with your right hand.
- Push the parking stand (2) down until the two skids are on the ground.
- Put your full body weight on the operating mandrel of the main standard.
- Pull the scooter towards the rear and simultaneously upwards onto parking stand.
- Check that the scooter is standing firmly.

## Checklist

### **Before each ride, carry out a safety check using the checklist.**

Take the safety check seriously. Carry out maintenance activities before you start you ride or ask a specialized dealer to do so. This will provide you with the certainty that your motorcycle corresponds to traffic regulations. A technically faultless motorcycle is a basic requirement for the safety of both yourself and other road users.

Before starting your ride, check the following.

- Steering (smooth and free play)
- Engine oil quantity
- Fuel quantity
- Front brake
- Rear brake
- Types (profile and pressure)
- Telescopic fork
- Load /lights
- Total weight
- Lights
- Brake fluid (lever)
- Brake (operation)

In case of problems or difficulties, contact a dealer, who will do everything possible to assist you.

### **WARNING**

**While the engine is running or the ignition is on, do not touch the ignition system.**

### **FIRE HAZARD**

**The exhaust system becomes very hot. While riding, idling or parking, make sure that to inflammable materials (e.g. hay, leaves, grass, coverings or luggage, etc.) can come into contact with it!**

## Load /lights



### WARNING

**For the sake of your safety, use only original accessories or products released by us.**

We cannot judge for each third-part product whether it can be safely used in combination with your scooter.

Nor can a official approval give such a guarantee in all cases, since the test scope is not always sufficient.



### NOTE

Our accessories and approved products as well as qualified advice are available from all specialized dealers.

## Correctly loaded

- Make sure that the left-right weight distribution is balanced.
- Check that fastenings are correct and tight - Do not transport bulky loads.
- Do not cover the lights



### WARNING

**The total allowable weight may not be exceeded.**

**Check the type pressure.**



### WARNING

**Before any ride, check the operation of all lighting components.**

- Check that the headlamps and lenses are clean.

## Ride safely



### CAUTION

**Riding safety is largely also determined by the manner of riding.**

Therefore:

- Put on a tested / approved safety helmet and correct close the buckle.
- Wear suitable protective clothes.
- Rest your feet on the footrests.
- Do not ride if your riding ability has been compromised.

Your reactions can be adversely affected not only by alcohol, but also by drugs and medicines.

- Strictly observe all traffic regulations.
- Always adapt your riding speed to the traffic and road conditions.

On smooth,slippery roads take into account that your riding stability and braking power are limited by the grip of the types on the road top.

## **Ride economically and be aware of the environment**

Fuel consumption, environmental pollution and wear of engine, brakes and tyres depend on various factors.

Your personal riding style is highly determinant for economical fuel consumption and exhaust gas and noise generation.

While idling, the engine takes a long time to warm up to operational temperature. In the warm-up phase, however, the wear level and pollutant emissions are very high. It is therefore best to start riding immediately after start-up.

### **Avoid rapid acceleration**

Open the throttle not further than needed, in order to reduce fuel consumption as well as pollution and wear levels.

Do not use excessive revs; change up as soon as possible and do not change down until it is necessary to do so.

### **Ride as evenly as possible and look ahead as far as possible.**

Unnecessary acceleration and hard braking cause high fuel consumption and increased pollution levels.

### **Turn the engine off when waiting in traffic.**

Different riding conditions affect fuel consumption. The following conditions are unfavourable for fuel consumption:

- High traffic density, especially in big cities with many stops for traffic lights.
- Frequent short rides with repeated starts and warm-ups of the engine.
- Riding in a column of motorcycles at low speed, meaning riding with relatively high revs.

Plan rides ahead of time in order to avoid heavy traffic.

Fuel consumption is also affected by conditions that are out of your control, for instance, poor road condition, hills, riding in winter.

Observe the following aspects for economical fuel consumption:

- The planned inspection intervals must be closely observed.
- Regular service by a specialized dealer will guarantee not only continued operability, but also economical fuel consumption, low environmental pollution and a long life span.
- Check the tire pressure every two weeks.

Low tire pressure increases rolling resistance. This increases fuel consumption and tire wear and adversely affects riding behaviour.

- Continually check fuel consumption.
- Frequently check the engine-oil level.

## Running-in

Running-in instructions for engine and transmission.

### CAUTION

Excessive revs while running-in the engine increases the wear of the engine.

Engine faults during the running-in period must be immediately reported to a specialized dealer.

### NOTE

During the running-in period, ride in frequently changing load and rpm ranges. Select winding and slightly hilly routes. Avoid constantly low rpm counts and full throttle under load.

- During the first 500 km:

Less than 1/2 throttle

-Up to 1.000 km:

Less than 3/4 throttle.

### CAUTION

The first inspection must be carried out

immediately after the first 1.000 km.

You can save yourself delays by making

An appointment with a specialized dealer in advance.

Running-in new tires

### CAUTION

New tires have a smooth surface. They must therefore be roughened by carefully running them in at various slanted positions.

Only then will the surface obtain its full grip!

Running-in new brake linings

### WARNING

New brake linings must be run-in and Will not have their full friction power until after 500 km.

The slightly reduced braking effect can Be compensated for by an increase in the pressure on the brake lever.

During this period, avoid unnecessary hard braking actions.

## Starting with the electric starter

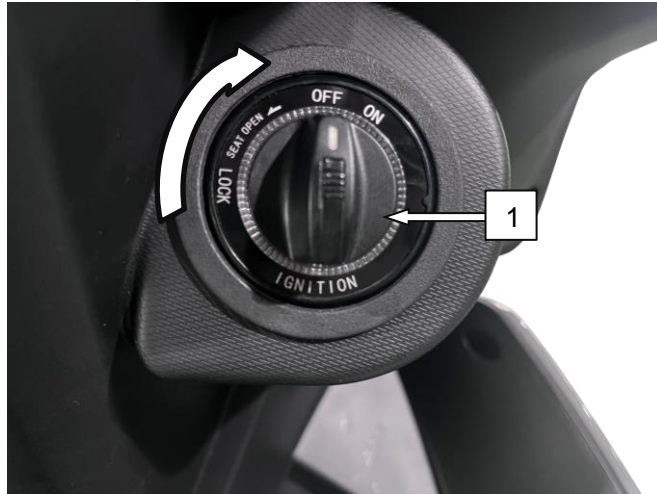

### **WARNING**

Propping up the scooter with the parking stand. Operate the rear handbrake lever to avoid a moving of the scooter.

Avoid high engine rpm's while the vehicle is standing still, otherwise the clutch will engage.

### **NOTE**

The scooter is equipped with a side stand switch. If the side stand is folded up the engine is shut down and will not start.

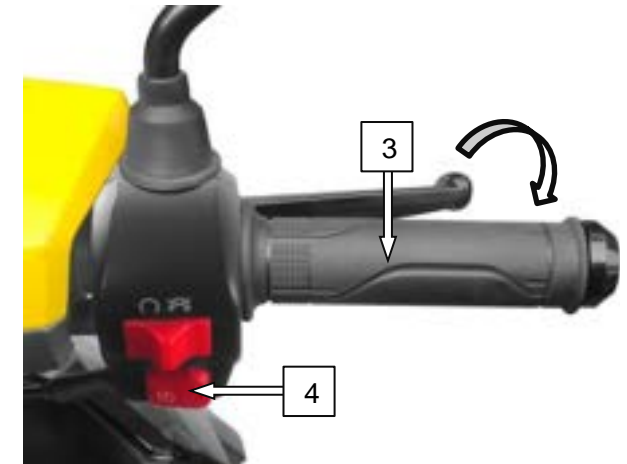

### **Before starting**

- Propping up the scooter with the parking stand.
- Keyless startup mode: press the knob on the smart car lock, the indicator lights up, and the knob can be turned to "ON" state;
- Emergency mechanical lock starting mode: lift the black cover on the front lock, insert the mechanical lock, the indicator light is on, the knob can be turned to "ON" state;
- Do not open the throttle (3).
- Pull and hold the handbrake lever (2).
- Operate the start button (4).
- If the engine can not be started after the starter motor is running for 3-5 seconds, open the throttle(3)1/8-1/4 turns and start

- Push the scooter off its parking stand.
- Mount the scooter.
- Release the brake before riding

### **CAUTION**

If the engine won't start immediately, re-lease the start button,wait a few seconds and push it again. Each time,push the st-art button for just a few seconds in order to save the battery. Never push the start button for more than 10 seconds.

### **WARNING**

Never allow the engine to run in an enclosed space. Exhaust gases are highly toxic and can kill.

## Braking

### Wet brakes

Washing the scooter or riding through water or rain can delay the braking effect due to wet or (in winter) ice-covered brake discs and linings.

### WARNING

**The brakes must first be operated until they are dry.**

### Salt film on the brakes

When riding on salted streets without braking for a while, the full braking effect may be delayed.

### Oil and grease

### WARNING

**The brake discs and linings must be free of oil and grease!**

**If the scooter is not used for a while, a rust film may form on the brakes and thus increase the braking effect. A thick rust film can cause the brakes to lock up. When setting out on a ride after a long lay-up period, carefully operate the brakes several times until they work normally.**

### NOTE

Make sure you practice braking for emergency situations, but do so where you will not pose a risk to yourself or others (e.g. a deserted parking area).

### WARNING

**Operate the brakes to grind off the salt deposited on the brake discs.**

### Dirty brakes

When riding on dirty streets, the braking effect can be delayed due to dirty brake discs and linings.

### WARNING

**Operate the brakes until they are clean. Lining wear is increased by dirty brakes!**

## Braking



### Braking

The front brake and rear brake are operated independently from each other. The front brake is operated via the right-hand brake lever(1)on the handlebars, and the rear brake is operated via the left-hand brake lever(2). When stopping or slowing down,release the throttle gas and operate both brakes at the same time.

On tight curves, sandy / dirty streets, wet asphalt and icy roads,use the front brake carefully: if the front wheel locks, the bike Will slide sideways. Brake with care.Locked wheels do not have much braking effect and can lead to skidding/crashing.In principle,do not brake on a curve,but before the curve. Braking on a curve increases the danger of sliding.



-Turn the knob (3) on the lock of the car to the " OFF " state.  
-When using the mechanical lock, remember to remove the ignition key.

## Servicing the scooter / cleaning agents

### NOTE

Regular, expert service will help maintain the value of your scooter and is a Condition for guarantee claims for corrosion and other such damage.

### CAUTION

Rubber and plastic parts will be damaged by caustic or penetrating cleaning agents or solvents.

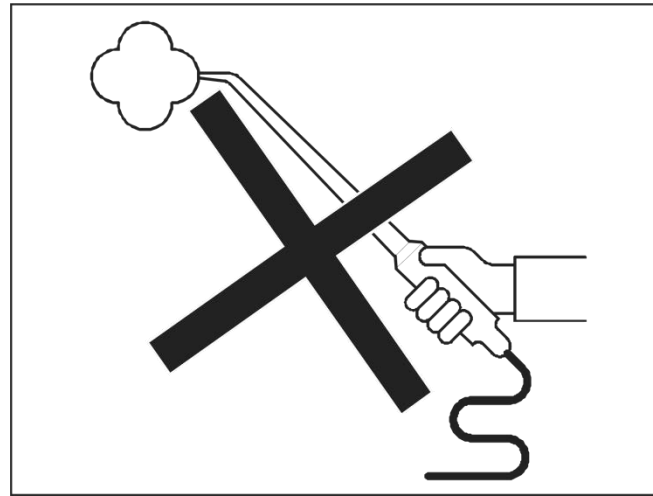

### WARNING

Always carry out a brake test after cleaning and before starting a ride!

### CAUTION

Do not use steam or high-pressure jet devices! Such devices can damage seals, the hydraulic braking system and the electrical system.

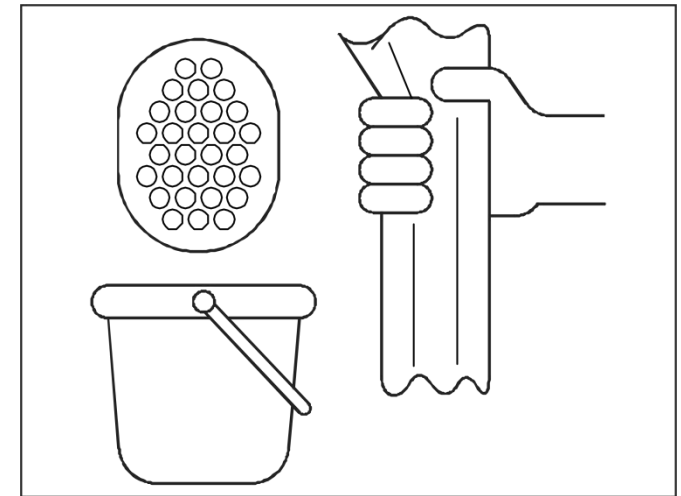

### CLEANING

- To wash the motorcycle, use a soft sponge and clean water.
- Afterwards, dry off with a polishing cloth or chamois.
- Do not wipe off dust or dirt with a dry cloth, to avoid scratching the paint or covering.

## Servicing the scooter / cleaning agents

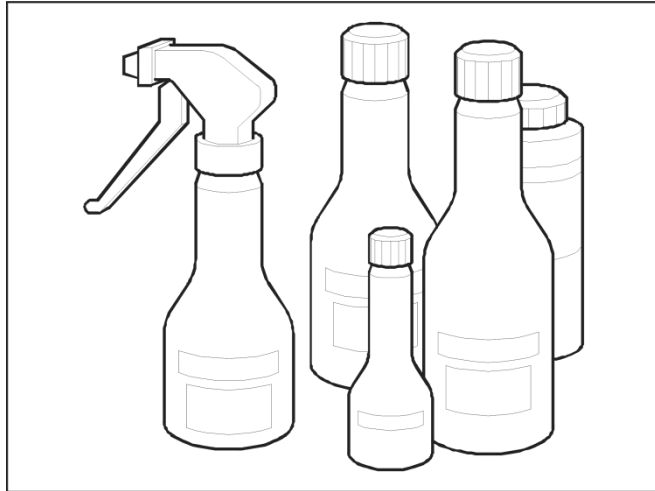

### PRESERVATION AGENTS

When necessary, the scooter must be preserved with commercially available preserving and cleaning agents.

- By way of precaution (especially in winter), regularly treat parts liable to corrosion with preservation agents.

### CAUTION

**Never use paint-polishing agents on plastic parts.**

- After a longish ride, thoroughly clean the chassis and the aluminium parts and preserve them with a commercially available anti-corrosion agent.

### Operation in winter and anti-corrosion protection

### NOTE

Protect the environment by using only environmentally friendly preservation agents, and use them frugally. Use of the motorcycle in the winter can cause considerable damage due to the presence of salt on the roads.

### CAUTION

**Do not use hot water, which would increase the effect of the salt**

-At the end of each ride, wash the motorcycle with cold water.  
-Thoroughly dry the motorcycle.  
- Treat parts liable to corrosion with wax borne anti-corrosion agents.

## Repairing paint damage

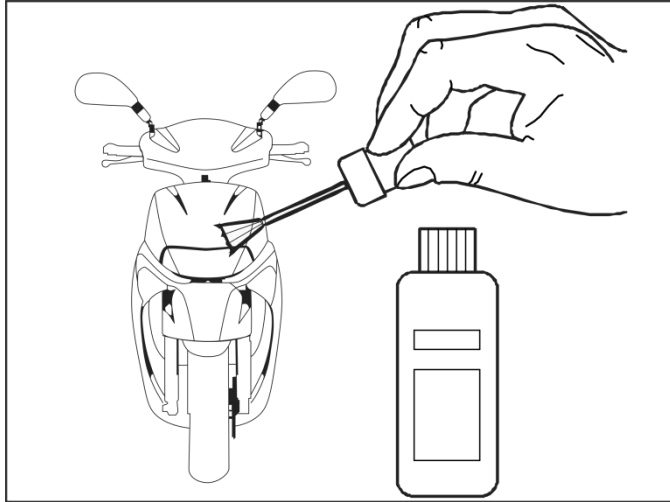

Minor paint damage should be immediately repaired.

## Servicing tires

If the scooter is not used for a longer period, it is recommended to support the Scooter so that its weight is not on the tires.

You can prevent the tires from becoming dry and brittle by spraying them with a silicone-rubber treatment. First thoroughly clean the tires.

Do not store the scooter or the tires in hot spaces (such as a boiler room) for longer periods.

### **WARNING**

**A minimum tire profile depth of 2.0 mm must be maintained at all times.**

## Lay-up / commission

### Lay-up

- Clean the scooter.
  - Remove the battery.
- Observe the maintenance instructions. Spray suitable lubricants on to the brake lever and the side standard and packing stand and bearings
- Rub bright/chromium-plated parts with acid-free grease (Vaseline)
  - Store the scooter in a dry room and jack it up so that its weight is not on the wheels.

### **NOTE**

Combine lay-up/ commission activities with an inspection by a dealer.

### Commission

- Remove the preservation agents from the outside.
- Clean the motorcycle.
- Install the charged battery.
- Preserve the battery terminals with terminal grease.
- Check / adjust the tire pressure.
- Check the brakes.
- Carry out activities according to the inspection plan.
- Carry out the safety checks.

## **Technical changes, accessories and spare parts**

### **WARNING**

**Technical changes to the scooter can lead to cancellation of the EC operating license.**

Should you want to make technical change-s, observe our guidelines. This will serve to prevent the scooter from being dam-aged and the traffic and operational safety being retained.A specialized dealer can carry out these activities with meticulous care.

Always consult a dealer before buying accessories or making any technical changes.

### **CAUTION**

**We recommend using only approved accessories and original spare parts for our scooter**

**This is in your own interests:the safety,suitability and reliability of these accessories and parts will have been tested specifically for the scooter.**

**Although we keep track of the market, we cannot evaluate nor be held liable for the quality of non-approved accessories and parts, even if they have a certificate of acceptance from an officially recognized technical testing / supervision agency, or a license issued by the authorities,**

For approved accessories and original spare parts, see a specialized dealer.

He will also ensure that they are professionally installed.

## Engine oil



### Checking the oil level

#### CAUTION

Checking the oil while the engine is cold will lead to a wrong measurement and therefore the wrong oil quantity. In order to avoid engine damage, never exceed the maximum oil level nor let it drop below the minimum level.

#### NOTE

Make sure that the scooter during oil-level checks stands level in all respects. Even the slightest inclination towards the side will produce measurement errors.



- Stop the warmed-up engine, wait for approx. 5 minutes and hold the scooter up-right.
- Propping up the scooter on the parking stand.
- Stop the engine and remove the oil filler cap(1) on the lower right of the crank-case.
- Clean the oil filler cap at the MIN-MAX area with a clean rag.

#### CAUTION

For checking the oil level only insert the oil filler cap and don't screw in! Otherwise there will be a wrong measurement in order to avoid engine damage.

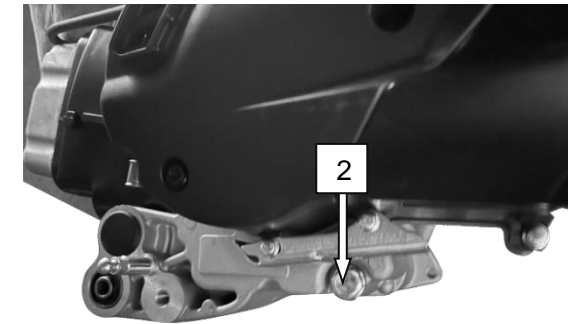

- The oil level must be between the minimum and maximum marks.
- Tighten the oil filler cap by hand.

If required, replenish the engine oil SAE 10 W/40 via the oil level up to the MAX level mark.

-When changing new engine oil, remove the oil hole screw(2), till all engine oil is flow out, then tighten the screw(2), add new oil till the level up to the MAX mark

## CAUTION

Do not use additives . Since the oil also serves to lubricate the clutch, do not use car engine oils supplemented with friction modifiers (such energy-conserving oil scan lead to the clutch slipping). Use a suitable, light engine oil for scooters , such as Motor SAE 15W/40 mineral oil API(SG or higher).

-If required, replenish the engine oil(for classification and viscosity, see the table) via the oil filler opening up to the maximum level marking.

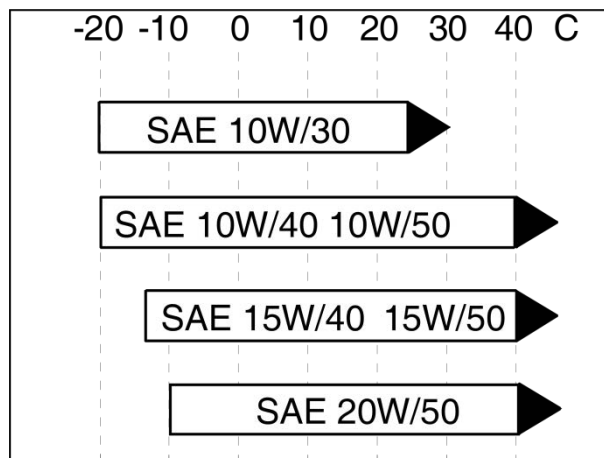

### Recommended grade:

Per API:SG or higher or also with additional release status: ACEA A3/96 (CCMC G5)

### Recommended viscosity:

Viscosity depends on the outside temperature. For short while, the temperature may exceed or fall short of the limits of the SAE grades.

The recommended viscosity grade SAE 15W/40 covers the ambient temperature range -15°C to +40°C and therefore represents the optimum for our latitudes.

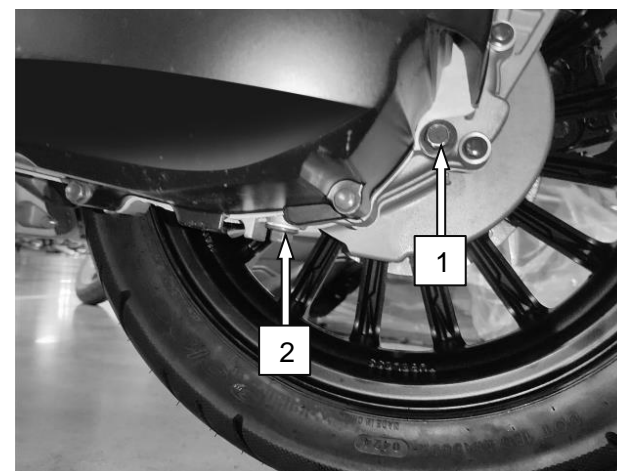

### Checking the transmission oil level

-Stop the warmed-up engine, wait for approx. 5 minutes.

-Propping up the scooter on the parking stand.

-Remove the oil filler screw (1) and check if the oil level is below the oil-filler opening.

-If required, replenish transmission oil Hypoid SAE 85W140 via the oil-filler opening

-When change new transmission oil, open the oil hole screw(2), till all transmission oil is flow out, then tighten the screw (2) and add new oil via the oil-filler opening.

-Tighten the oil filler screw(1).

## Checking the steering bearings



### NOTE

The telescopic fork should not jam up  
When turned and it should swing back lightly to both end positions.

- Pull the hand brake to block the front wheel brake.
- Hold the handlebar with both hands and try to move the handle bar(1)back and front If the fork column bearing shows noticeable play, it must be adjusted by a specialized dealer.

## Checking the telescopic fork

- Pull the hand brake to block the front wheel brake.
- Now pump the fork girders (2)several times up and down using the handlebar.
- The suspension should respond perfectly
- Check the fork girders for oil leaks.

### NOTE

If damage to the telescopic fork or the spring strut is found have the motorbike examined by a professional dealer.

## Tire profile



### Checking the tire profiles

#### ⚠ WARNING

Observe the minimum profile depth prescribed by law.

Never ride without valve caps(1). Firmly tightened valve caps prevent the tire from suddenly losing pressure.

-Measure the profile depth at the centre (2) of the tire's tread.

Recommended minimum profile depth:2.0 mm

Observe the wear marks(3).

### Checking the tire pressure

#### ⚠ WARNING

Adjust the tire pressure according to the total weight load. Never exceed the rated total weight or the bearing capacity of the tires. Incorrect tire pressure will have a considerable effect on the riding properties of the scooter and the lifespan of the tires.

- While the tires are cold.

- Twist off the valve caps.

-Check /adjust the tire pressure.

-Twist on the valve caps.

### Tire pressure

One Rider: Front: 220kpaRear: 250kpa

Two Rider: Front: 250kpaRear: 270kpa

### Tire size

The standard scooter is provided with the following tire sizes:

Front:120/60-13 50p

Rear:130/60-13 63p

All Tires are tubeless.

#### ⚠ WARNING

Use only tires approved by the manufacturer. The use of non-approved tire brands, types or sizes leads to the operating permit of the Vehicle becoming null and void. Use only pairs of tires produced by the same manufacturer.

## Cleaning and replacing the air filter

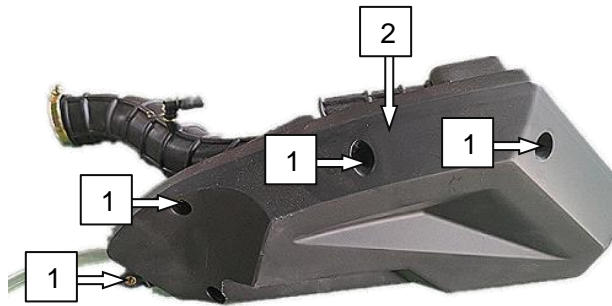

### NOTE

The scooter is attached with a oil foam air filter. In case of heavy dirtiness the paper filter element (3) has to be replaced.

### Disassembly and cleaning

- Remove cross screws(1) and take off the air filter cover(2).
- Take off the paper filter element (3).
- Dust out the paper filter and clean with air pressure or replace if necessary.



### Installation

### NOTE

-Usually the installation takes place in reverse order to disassembly.

### CAUTION

Never run the engine without air filter.

- Dust deposit is one of the major causes of reducing output horsepower and increasing Fuel consumption.
- Change the air cleaner element more frequently to prolong the engine's service life if the scooter is ride on dusty roads very often.
- Check for properly installation of the foam housing in the filter case.
- Otherwise the engine runs poorly or lead to serious engine damage.
- Be careful not to soak the air cleaner when washing the scooter. Otherwise it will cause engine hard to start.

## Checking the fuse

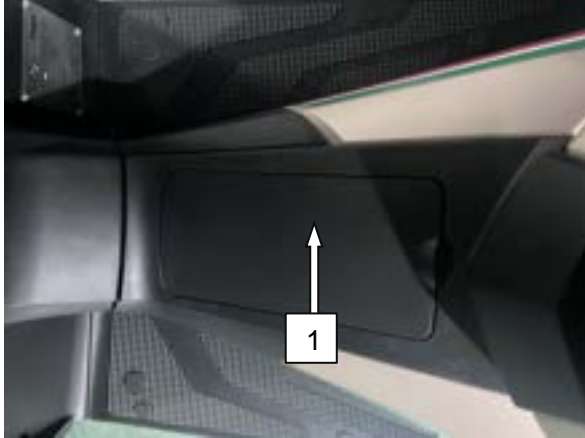

### CAUTION

**Never install a fuse with a larger rating, Since this could destroy the entire electrical system.**

The fuse is located below the front of the seat cushion.

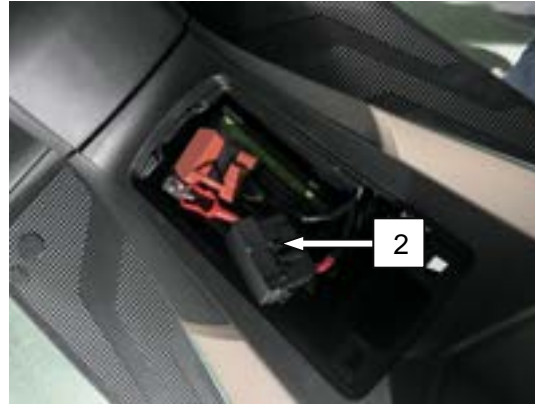

- Turn off the ignition.
  - Open the battery case cover(1).
  - Open the fuse case (2) and remove the fuse.
  - A faulty or blown fuse must be replaced by a new one with 20 A.
- Check the fuse for correct contact. Loose fuse will blow.

Installation takes place in reverse order to disassembly.

## Battery

### **WARNING**

Always wear safety glasses. Keep children away from acids and batteries.

### **EXPLOSION DANGER**

A battery being charged produces a highly explosive gas, which is why fire, sparks, naked flames and smoking are prohibited.

### **FIRE HAZARD**

Avoid generating sparks and electrostatic discharges when handling cables and electrical devices. Avoid short circuits.

### **DANGER-CAUSTIC ACTION**

Battery acid is highly caustic, so always wear safety gloves and glasses.

Do not tilt the battery as acid can leak from the ventilation openings.

### **FIRST AID**

If acid comes into contact with an eye, immediately flush the eye for several minutes with fresh water. Then immediately visit /call a doctor.

Acid on the skin or clothing must immediately be neutralized using acid converter or soap suds, and the spots must be flushed with plenty of water.

If acid is swallowed, immediately visit/call a doctor.

### **CAUTION**

Do not expose batteries to direct sunlight. Discharged batteries can freeze, so they must be stored in a place where the temperature remains above 5°-15°C.

Professional maintenance, charging and storage will increase the lifespan of the battery and create a condition for the honoring of guarantee claims.

### **WARNING**

Take a dead battery to a collection point. Never dispose of one with household refuse.

## Charging the battery

After a long lay-up (3-4 months), charge the battery. The charging current (in amperes) must not exceed 1/10" of the battery capacity (Ah).

The battery must not be fast-charged. The battery may only be charged using a special charger approved for MF batteries.

## Maintenance

Although the battery is maintenance-free. Never leave the battery discharged. Keep the battery clean and dry and make sure that the connection terminals are firmly seated.

## Removing and installing the battery



### CAUTION

The battery may only be connected or disconnected while the ignition is inactive.



### CAUTION

The battery may only be connected or disconnected while the ignition is inactive.

- Turn off the ignition.
- Turn the ignition key to the left and open the seat cushion(2).
- Remove the two screw (3)and open the battery cover (4).
- First disconnect the minus terminal (5,black cable ).Then disconnect the plus terminal(6, red cable).
- Disconnect the battery.
- Remove the battery.

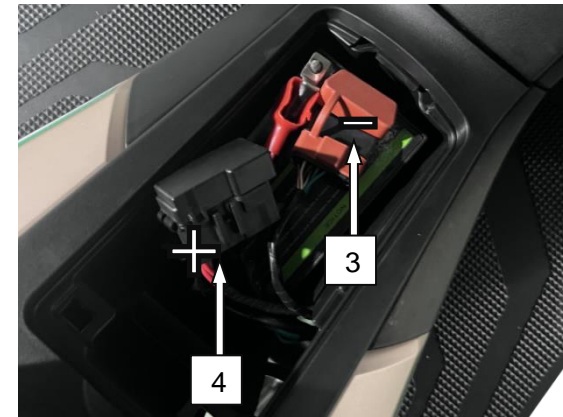

Installation takes place in reverse order to disassembly

When installing the battery,first connect the plus terminal (6,red cable)

The battery is maintenance-free.Do not try to open it.

<b>TR200T-5 Main technical parameters</b>	
<b>Engine type</b>	1P61QMK
Construction:	Single cylinder,4-stroke
Displacement:	168.9ml
Bore:	φ61mm
Stroke:	57.8mm
Compression ratio:	9.2:1
Cooling:	Air-cooled
Maximum net power output:	8.3kW/7000rpm
Maximum net torque:	12N.m/5500rpm
Ignition system:	Transistorized ignition system with electronic ignition control (ECU)
Spark plug:	NGK CR7HSA
Electrode gap:	0.6-0.7mm
Fuel supply:	92(unleaded gasoline)
Idle speed:	1700±100r/min
Air-filter:	Element air-cleaner
Type of starter:	Electric starter

<b>TR200T-5 Main technical parameters</b>	
<b>Power transmission</b>	
Clutch:	Centrifugal type
Transmission:	CVT
<b>Chassis</b>	
Scooter version:	TR200T-5
Front suspension:	Positive shock absorption
Rear suspension:	Spring hydraulic shock absorption
Wheels front:	Light metal (Alu)MT3.50x13
Wheels rear:	Light metal (Alu)J13x3.50
Tires front:	120/60-13
Tires rear:	130/60-13
Tire pressure:	One Rider: Front:225kpa      Rear:250kpa
	Two Rider: Front:250kpa      Rear:270kpa
Brakes,front:	Disc CBS
Brakes,rear:	Disc CBS

<b>TR200T-5 Main technical parameters</b>	
<b>Lubricants and operating fluids</b>	
Fuel tank capacity:	10.5 Liter
Fuel:	Unleaded fuel min.92 octane
Engine oil: Filling quantity:	SF 10W-40 0.9 liters
Transmission oil: Filling quantity:	85W/-90 0.14liters
<b>Electrical Equipment</b>	
Generator:	12V200W
Battery:	12V 6Ah MF
Fuse:	20A
Head light:	Low beam/High beam 12V7.5W/8W
Position light:	LED 12V2.6W
Instrument lights Speedometer:	LED 12V 0.1W
Control lights indicator and high beam:	LED 12V 0.8W
Brake/rear light:	LED 12V2W/0.5W
Front/rear turn signal light:	LED FR:2x12V1.5W RR:2x12V2.2W

<b>TR200T-5 Main technical parameters</b>	
<b>Dimensions and weights</b>	
Overall length:	1860mm
Width across handlebars:	675mm without rear view mirror
Maximum height:	1170 mm without rear view mirror
Wheel base:	1330mm
Seat height:	780mm
Net Weight	141kg
Top speed:	94km/h

## Warranty conditions

In case of an occurring fault we will provide the customer with the following performances through the authorized dealer (seller) within the scope of its statutory warranty obligations:

1. Within a period of 24 months after the delivery of the motorbike to the end customer the company we will rectify any deficiencies caused by material or manufacturing faults through the authorized dealer (seller) by repairing or replacing the affected part according to the statutory warranty regulations. We may deny the requested repair or replacement of the faulty part if this would only be possible with disproportionately high costs. In this case we rectify the deficiency through the authorized dealer (seller) by applying the other possible type of subsequent fulfillment. If both types of subsequent fulfillment

are only possible with unproportionately high costs, we deny the subsequent fulfillment all-together through the authorized dealer (seller). The customer is then entitled to legal claims. Replaced parts pass over into the possession of us.

2. The installation of spare parts within the scope of warranty does not extend the warranty period that has started with the date of delivery of the motorcycle.

3. The warranty does not cover normal wear and tear caused by normal use as well as wear and tear caused by inappropriate handling and inappropriate use. Oxidation and corrosion are caused by environmental influences and are also not covered under warranty.

4. Warranty claims lodged by the customer will be rejected in case of: Manipulations to the motorcycle, installation of a different exhaust system, changes to the gear-box or secondary transmission ratio and

installation of accessories or spare parts which have not been approved by us. Repairs carried out in workshops not authorized by us and the noncompliance with the maintenance intervals in the workshop of an authorized dealer will also cause the rejection of warranty claims.

5. When lodging a warranty claim the customer must present the correctly filled in service book to the seller.

6. The following table gives the customer an overview of the average limits of the respective wear parts.

## List of wear parts

Wear parts	Wear limits
Tires,houses,rims	depending on riding style,load and tire pressure the wear limit may already be reached after only 500 km or even earlier.
Wheels,hubs	depending on riding style,load and tire pressure the wear limit may already be reached after only 1500 km or even earlier.Check during each maintenance Oxidation is a lack of maintenance!
Oils,air filter,leakage inspection on engine	during the first inspection,then with every maintenance interval(every 3000 km/6000 km).Check oil level before every ride.
Spring fork,spring strut	Cleaning /inspection during every maintenance.
Lamps,incandescent bulbs,electric system	depending on road conditions /unevenness of the road surface the lifetime will be reduced,this may already occur after 500 km.
Brake linings,brake shoes,brake lines	depending on riding style and load these may already be worn after 1500 km, in cross-country operation even earlier.
Sedal rings,sealants,O-rings	must be replaced during each maintenance interval to ensure proper function.
Radial seals on engine,gearbox,fork and wheels	depending on road conditions and care wear may start after 500 km. Dirt reduces the lifetime.Do not clean with a high pressure cleaner!
Wheel bearings,steering bearings	depending on road conditions and care wear may start after 1500 km. Soiling of the wheel hub reduces the lifetime. Check during each maintenance interval,do not clean with a high pressure cleaner!
Swing arm bearing	depending on load and care after 1500 km,check with every maintenance.
Cables	depending on care starting after 500 km.Check with every maintenance.
Coverings	Plastic parts will be damaged by caustic or penetrating cleaning agents or solvents.

Wear parts	Wear limits
Air cleaner,oil filter	with each maintenance interval.
Starter battery,batteries,fuses,starter brushes	depending on ambient temperatures failures can be expected in the 6th month, when used for short rides even earlier.
Mirror glasses	depending on ambient temperatures and care failures can be expected in the 6th month, in winter operation even earlier.Oxidation is a lack of maintenance!
Bowden cables,brake cables,throttle cables	depending on use and care from the 6th month
Self-locking nuts,cotter pins locking plates bonded screw connections	during each maintenance interval or after unscrewing the nut or unlocking the lock.
Variometer,CVT,rolls,belts	depending on riding style and load these may be worn after 500 km.
Clutch linings/friction discs	depending on riding style and load these may be worn after 500 km.
Pistons,cylinders,crankshaft,conrods,engine bearings	depending on riding style,load and care these parts may be worn after 200 hours. When riding mainly with full throttle even earlier.
Spark plug	with each or every second maintenance interval.
Exhaust system,inspection of mountings	depending on use and care from the 6th month,in winter and short distance operation even earlier.Oxidation is a lack of maintenance!

**Please observe the following:**

-During and after the warranty period all inspections should solely be performed by a specialized dealer approved by us

-Observe the inspection intervals and have the specialized dealer confirm them on the guarantee certificate.

-Use only original spare parts.



**CAUTION**

**In case of non-compliance the warranty will become null and void.**

The various activities carried out are listed on the inspection plan.

During the warranty period the following inspection intervals must be complied with:

At 1.000 km (1\*service)

Every 3.000 km /or after 6 months

Every 6.000 km /or after 12 months

After the warranty period the inspection intervals specified in this manual must be applied as follows:

Every 3.000 km/6 months

Every 6.000 km/12 months



**WARNING**

**For safety reasons,do not carry out any repair or adjustment activities to the scooter and chassis that exceed a closely restricted scope.Tinkering with safety-relevant parts could threaten the safety of yourself and third parties.**

**This applied especially to the exhaust system,carburettor,ignition system,fork column,brake system and lights.**

**Before starting work on the electrical system,disconnect the minus terminal of the battery.**

## List of trouble codes

Fault Code	Description of DTC
P 0118	Engine Coolant Temperature Sensor Circuit High
P 0117	Engine Coolant Temperature Sensor Circuit Low
P 0116	Engine Coolant Temperature Sensor signal stuck
P 1116	Engine Coolant Temperature Sensor High at start up
P 0335	Crankshaft Position Sensor "A"Circuit
P 2301	Ignition Coil "A"Primary Control Circuit High
P 2300	Ignition Coil "A"Primary Control Circuit Low
P 0123	Throttle Position Sensor/Switch "A"Circuit High
P 0122	Throttle Position Sensor/Switch "A"Circuit Low
P 0459	Evaporative emission system purge control valve "A"Circuit High
P 0458	Evaporative emission system purge control valve "A"Circuit Low
P 0232	Fuel Pump circuit short High
P 0231	Fuel Pump circuit short Low
P 0601	Internal Control Module Memory Checksum Error
P 0262	Cylinder 1 Fuel Injector "A"Circuit High
P 0261	Cylinder 1 Fuel Injector "A"Circuit Low
P 0108	Manifold Absolute Pressure Sensor Circuit High
P 0107	Manifold Absolute Pressure Sensor Circuit Low



## List of trouble codes

Fault Code	Description of DTC
P3106	Manifold Absolute Pressure Sensor rationality at low TPS
P0105	Manifold Absolute Pressure Sensor signal stuck
P0113	Intake Air Temperature Sensor Circuit High
P0112	Intake Air Temperature Sensor Circuit Low
P0111	Intake Air Temperature Sensor signal stuck
P0114	Intake Air Temperature Sensor Circuit Intermittent
P0132	02 Sensor Circuit High Voltage Bank 1 Sensor 1
P0131	02 Sensor Circuit Low Voltage Bank 1 Sensor 1
P2195	02 Sensor Signal Lean at PE
P014D	02 Sensor Slow Response-Lean to Rich Bank 1 Sensor 1
P014C	02 Sensor Slow Response-Lean to Rich Bank 1 Sensor 1
P0031	02 Sensor Heater Control Circuit Low Bank 1 Sensor 1
P0032	02 Sensor Heater Control Circuit High Bank 1 Sensor 1
P00D1	02 Sensor Heater current low
P0301	Cylinder 1 Misfire Detected
P0500	Vehicle Speed Sensor "A" Circuit
P0505	Idle air control system error

**I =Inspection, cleaning, and adjustment**

**A=Replacement**

**R=Cleaning (replaced if necessary)**

**S=Lubrication**

<b>Component Assembly</b>	<b>Before each trip</b>	<b>1 st service after 1000 km</b>	<b>Every 3.000 km / 6 months</b>	<b>Every 6.000 km / 12 months</b>	<b>Every 12.000 km / 24 months</b>
Air cleaner foam	I	I	R		A
Oil filter (screen)			R		
Engine oil	I	A	A		
Fuel filter	I	I	I		A
Spark plug	I	I	I		A
Ignition time		I	I		
Valve clearance		I		I	
Compression check			I		
Carburetor (Idle speed)	I	I	I		
Throttle cable adjustment	I	I	I		
Transmission oil	I	A	I	A	
Transmission check for leakage	I	I	I		
Crankcase check for leakage	I	I	I		
Crankcase ventilation		I	I		
Driving belt, fight weight			I	I/A	
Clutch discs			I	I/A	



<b>I =Inspection, cleaning, and adjustment</b> <b>A=Replacement</b> <b>R=Cleaning (replaced if necessary)</b> <b>S=Lubrication</b>					
<b>Component Assembly</b>	<b>Before each trip</b>	<b>1 st service after 1000 km</b>	<b>Every 3.000 km / 6 months</b>	<b>Every 6.000 km / 12 months</b>	<b>Every 12.000 km / 24 months</b>
Bolts and nuts (engine)	I	I	I		
Compression teat			I		
Exhaust system		I	I		
Fuel tank, fuel hoses	I	I	I		
Battery	I	I	I		
Steering and bearings	I	I	I		
Front and rear suspension	I	I		I	
Shock absorption	I	I		I	
Tire pressure	I	I	I		
Brake function, brake pads	I	I	I		
Brake fluid	I	I	I		<b>A/every 2 years</b>
Main-and side stand	I	I	<b>I/S</b>		
Bolts and nuts (chassis)	I	I	I		

1.000 km/1 months  
1st service  
dealer stamp:

km.....  
Date.....

After 3.000 km/6 months  
dealer stamp:

km.....  
Date.....

After 6.000 km/12 months  
dealer stamp:

km.....  
Date.....

After 9.000 km/18 months  
dealer stamp:

km.....  
Date.....

After 12.000 km/24 months  
dealer stamp:

km.....  
Date.....

After 15.000 km/30 months  
dealer stamp:

km.....  
Date.....

After 18.000 km/36 months  
dealer stamp:

km.....  
Date.....

After 21.000 km/42 months  
dealer stamp:

km.....  
Date.....

New brake fluid  
Yes            no

km.....  
Date.....

Stamp,signature

New brake fluid  
Yes            no

km.....  
Date.....

Stamp,signature

New brake fluid  
Yes            no

km.....  
Date.....

Stamp,signature

New brake fluid  
Yes            no

km.....  
Date.....

Stamp,signature