

Parts No.	Discription	Qty per Vehicle
-----------	-------------	-----------------

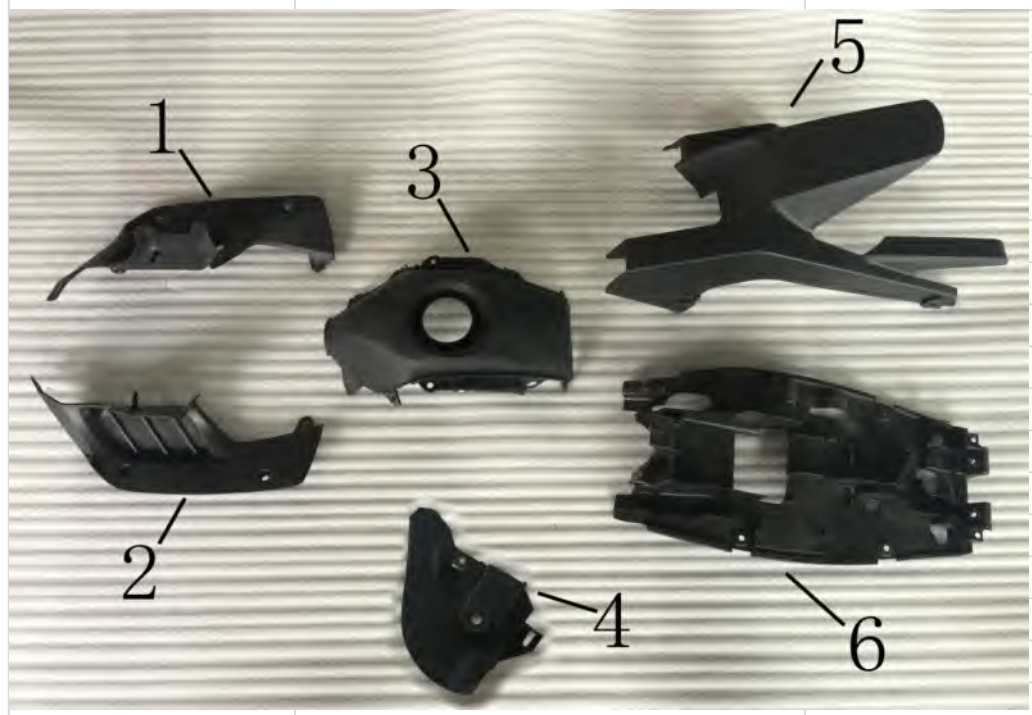

PMZ125-1-A-001	front fender	1
PMZ125-1-A-002	frame fender RH	1
PMZ125-1-A-003	frame fender LH	1
PMZ125-1-A-004	FACE COVER ORNEMENT, LH	1
PMZ125-1-A-005	FACE COVER ORNEMENT, RH	1
PMZ125-1-A-006	ORNEMENT COVER RH	1
PMZ125-1-A-007	ORNEMENT COVER LH	1
PMZ125-1-A-008	FRONT FACE COVER LH	1
PMZ125-1-A-009	FRONT FACE COVER RH	1
PMZ125-1-A-010	REAR PLATE RH	1
PMZ125-1-A-011	REAR PLATE LH	1
PMZ125-1-A-012	REAR PLATE	1



PMZ125-1-B-001	INNER SIDE COVER RH	1
PMZ125-1-B-002	INNER SIDE COVER LH	1
PMZ125-1-B-003	FUEL TANK COVER	1
PMZ125-1-B-004	INNER SIDE COVER	1
PMZ125-1-B-005	REAR FENDER	1
PMZ125-1-B-006	INNER FENDER	1

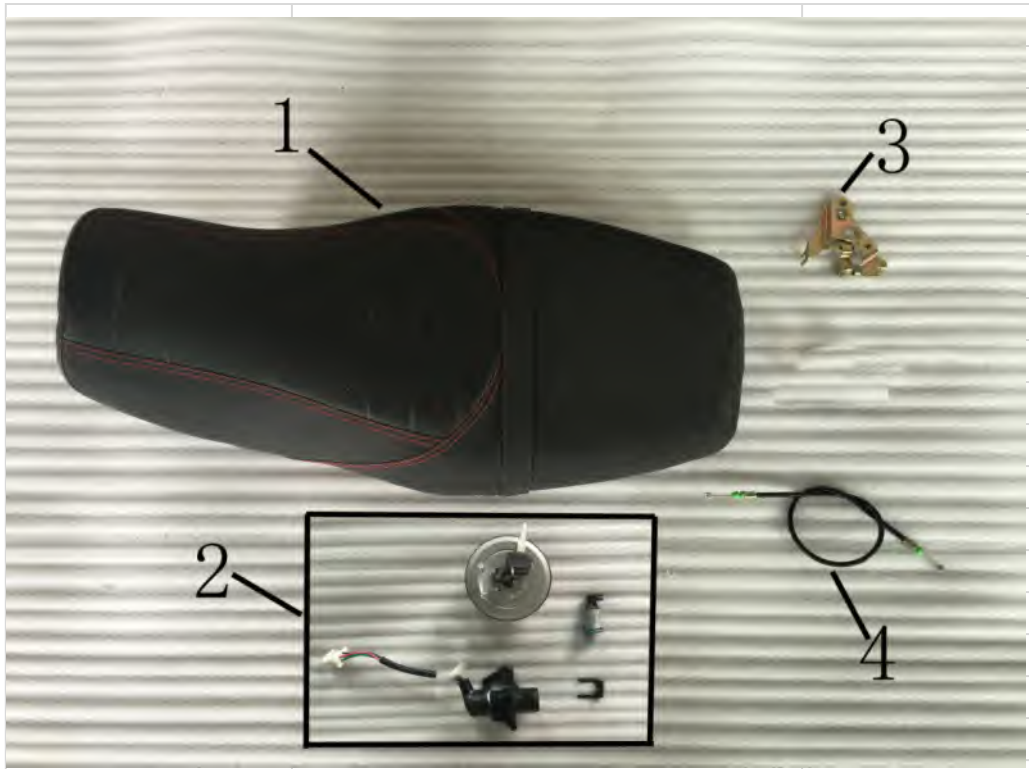

PMZ125-1-C-001	seat	1
PMZ125-1-C-002	ignition assy	1
PMZ125-1-C-003	seat lock	1
PMZ125-1-C-004	seat cable	1

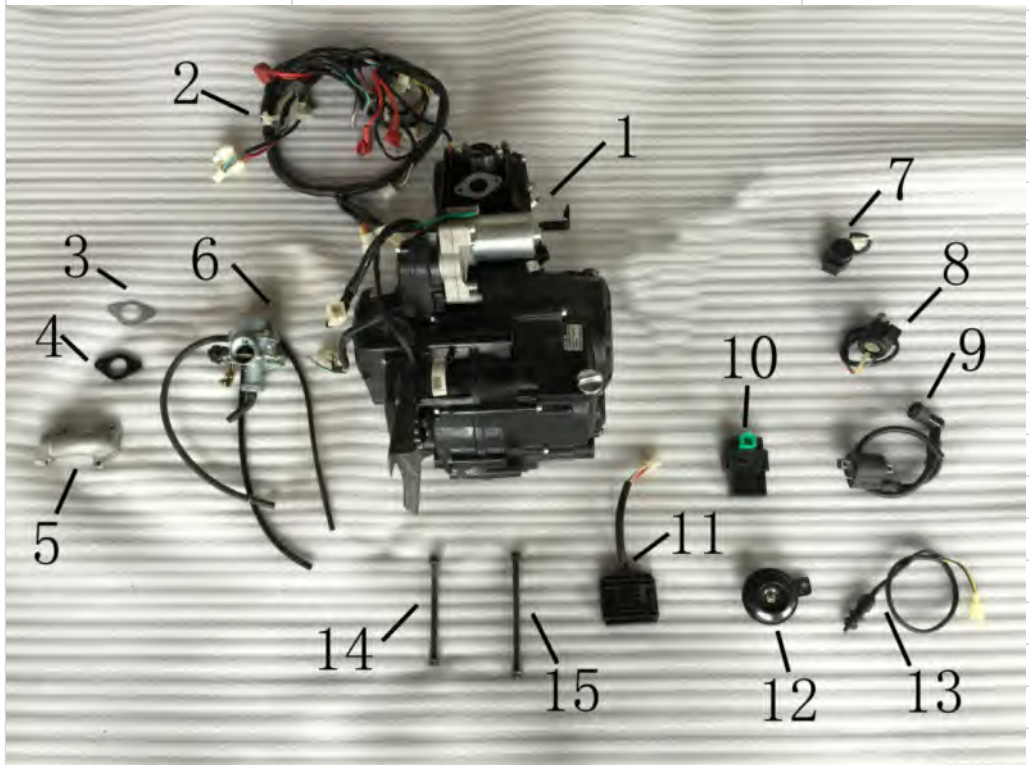

PMZ125-1-D-001	ENGINE	1
PMZ125-1-D-001-01	FRONT SPROCKET COVER	
PMZ125-1-D-001-02	MAGNETO COVER	
PMZ125-1-D-001-03	ENGINE GASKET	
PMZ125-1-D-001-04	PISTON & RING SET	
PMZ125-1-D-001-05	CLUTCH ASSY	
PMZ125-1-D-001-06	CLUTCH SENSOR	
PMZ125-1-D-001-07	STATOR	

PMZ125-1-D-001-08	STARTER	
PMZ125-1-D-002	MAIN WIRES	1
PMZ125-1-D-003	INTAKE PIPE WASHER	1
PMZ125-1-D-004	INTAKE PIPE RUBBER WASHER	1
PMZ125-1-D-005	INTAKE PIPE	1
PMZ125-1-D-006	CARBURETOR	1
PMZ125-1-D-007	RELAY ASSY,TUN SIGNAL	1
PMZ125-1-D-008	STARTER RELAY	1
PMZ125-1-D-009	IGNITION COIL	1
PMZ125-1-D-010	CDI	1
PMZ125-1-D-011	REGULATOR	1
PMZ125-1-D-012	HORN	1
PMZ125-1-D-013	SPEEDO CABLE	1
PMZ125-1-D-014	ENGINE AXLE 1	1
PMZ125-1-D-015	ENGINE AXLE 2	1

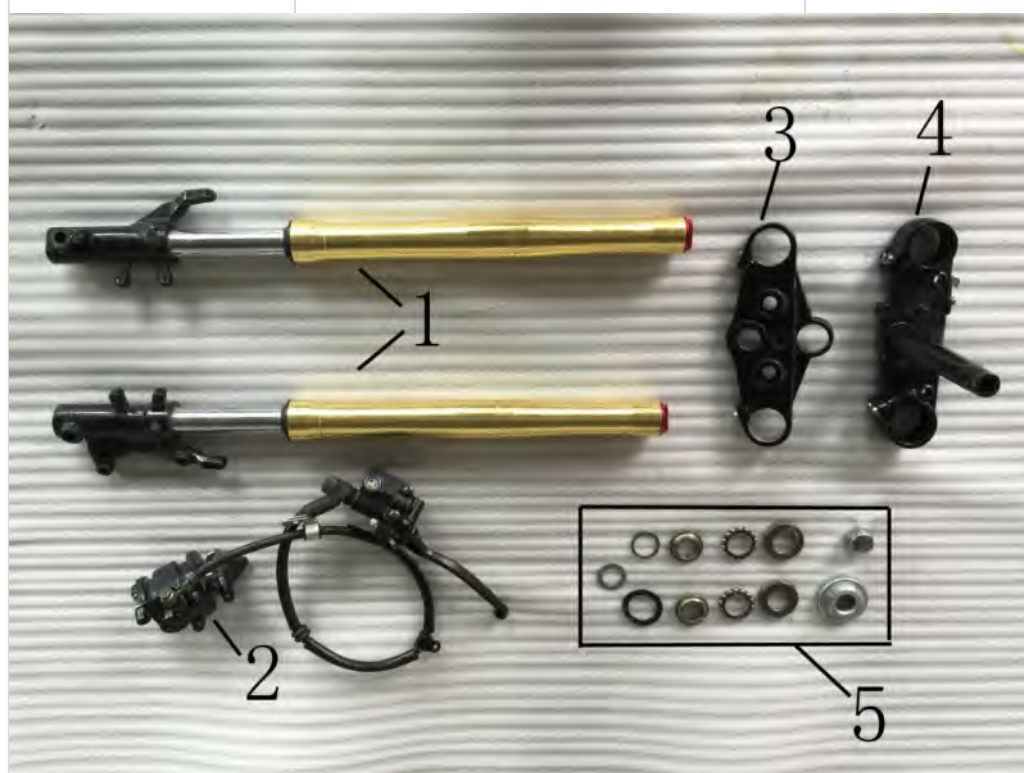

PMZ125-1-E-001	FRONT FORK	1
PMZ125-1-E-002-01	FRONT BRAKE	1
PMZ125-1-E-002-02	FRONT BRAKE LINE CLAMP	
PMZ125-1-E-002-03	FRONT BRAKE PAD SET	
PMZ125-1-E-003	STEERING HEAD	1
PMZ125-1-E-004	STEERING STEM	1
PMZ125-1-E-005	STEEL BOWEL	1



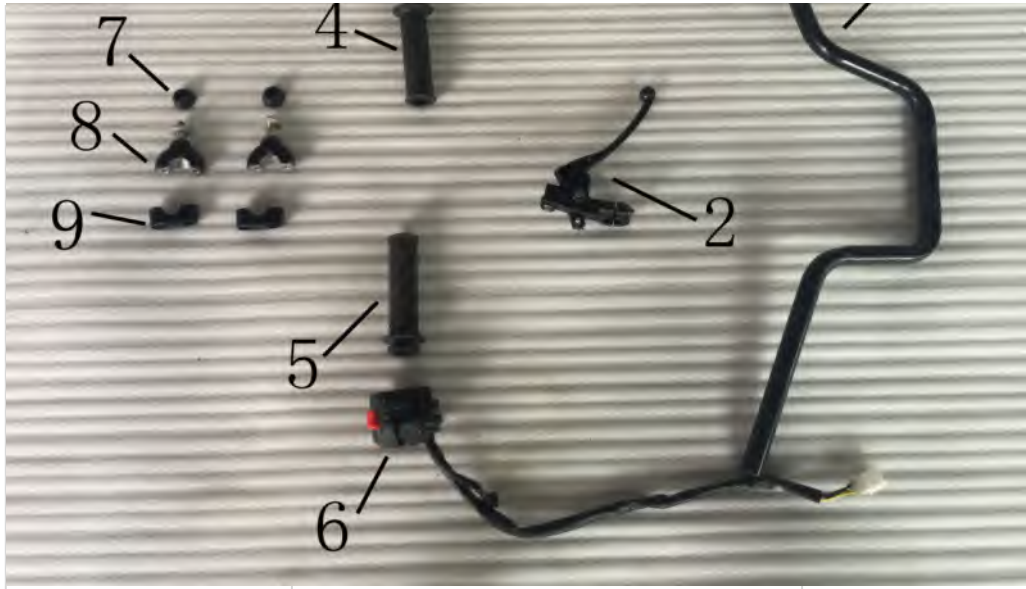

PMZ125-1-F-001	HANDLEBAR	1
PMZ125-1-F-002	CLUTCH PERCH W/LEVER	1
PMZ125-1-F-002-01	CLUTCH LEVER	
PMZ125-1-F-003	LEFT CONTROL PANEL	1
PMZ125-1-F-004	HAND GRIP(LEFT)	1
PMZ125-1-F-005	HAND GRIP(RIGHT)	1
PMZ125-1-F-006	RIGHT CONTROL PANEL	1
PMZ125-1-F-007	RUBBER WASHER	1
PMZ125-1-F-008	HANDLEBAR HOLDER	1
PMZ125-1-F-009	HANDLEBAR HOLDER	1





PMZ125-1-G-001	FOOT RESTER RH(BLACK)	1
PMZ125-1-G-002	FOOT RESTER LH (BLACK)	1
PMZ125-1-G-003	KICK STAND	1
PMZ125-1-G-004	BRAKE PEDAL LEVER	1
PMZ125-1-G-005	GEAR SHIFTER	1
PMZ125-1-G-006	REAR BRAKE	1
PMZ125-1-G-006-01	REAR BRAKE PAD SET	
PMZ125-1-G-006-02	Rubber peg insert	



PMZ125-1-H-001	MUFFER	1
PMZ125-1-H-002	EXHAUST	
PMZ125-1-H-002-01	EXHAUST GASKET	
PMZ125-1-H-003	BRACKET HEAD LIGHT	1
PMZ125-1-H-004	BRACKET TAIL LIGHT	1
PMZ125-1-H-005	AIR FILTER	1



PMZ125-1-I-001	REAR BUSHING	1
PMZ125-1-I-002	SWING ARM	1
PMZ125-1-I-003	REAR SHOCK	1
PMZ125-1-I-004	CHAIN ADJUSTER	2

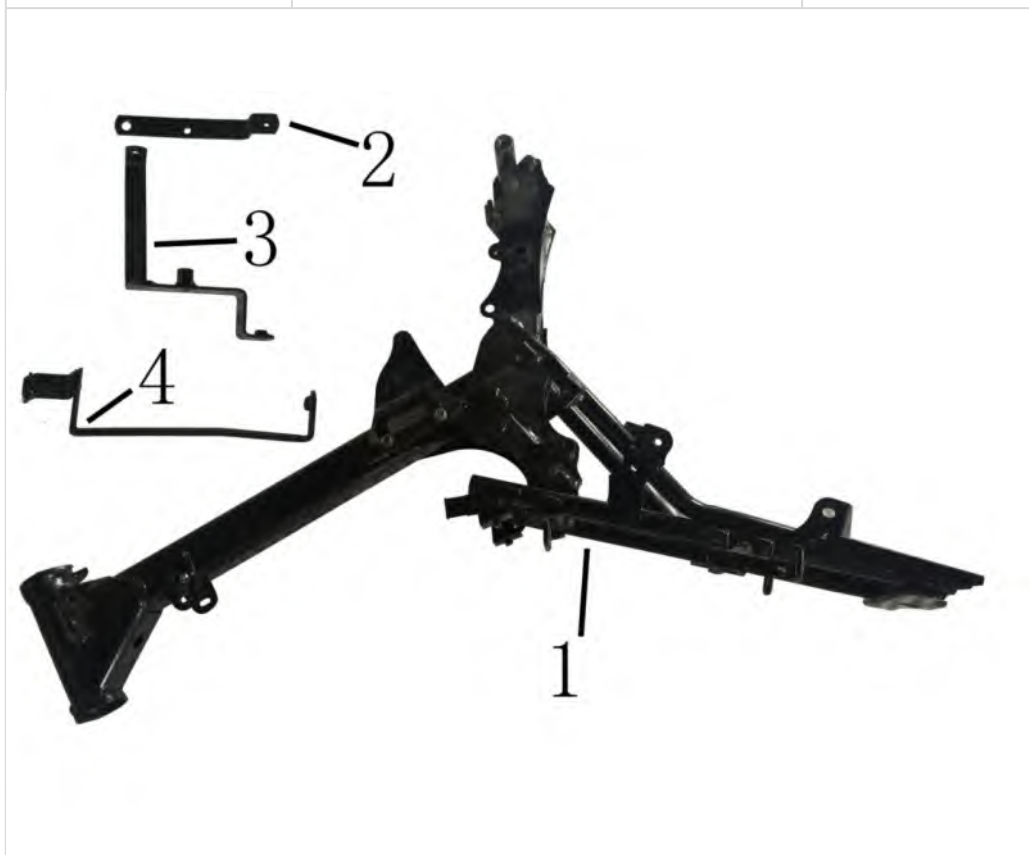

PMZ125-1-J-001	FRAME	1
PMZ125-1-J-002	BRACKET 1	1
PMZ125-1-J-003	BRACKET 2	1
PMZ125-1-J-004	BRACKET 3	1

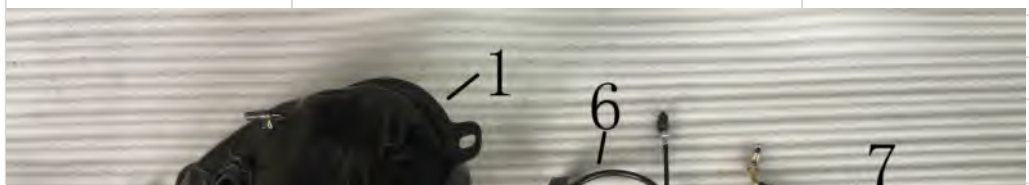



PMZ125-1-K-001	FUEL TANK	1
PMZ125-1-K-001-02	Fuel Filter	
PMZ125-1-K-002	FUEL TANK RUBBER WASHER	1
PMZ125-1-K-003	REAR MIRROR	2
PMZ125-1-K-004	GAS SENSOR (NO SEAL)	1
PMZ125-1-K-005	BATTERY	1
PMZ125-1-K-006	CLUTCH CABLE	1
PMZ125-1-K-007	CHOKE CABLE	1
PMZ125-1-K-008	SPEED SENSOR	1
PMZ125-1-K-009	Throttle cable	1





PMZ125-1-L-001	REAR TIRE	1
PMZ125-1-L-002	REAR RIM	1
PMZ125-1-L-003	REAR BRAKE DISC	1
PMZ125-1-L-004	SPROCKET HOLDER	1
PMZ125-1-L-005	SPROCKET	1
PMZ125-1-L-006	SPROCKET RUBBER WASHER	1
PMZ125-1-L-007	REAR AXLE	1
PMZ125-1-L-008	NUT	1
PMZ125-1-L-009	BUSHING	1
PMZ125-1-L-010	CHAIN	

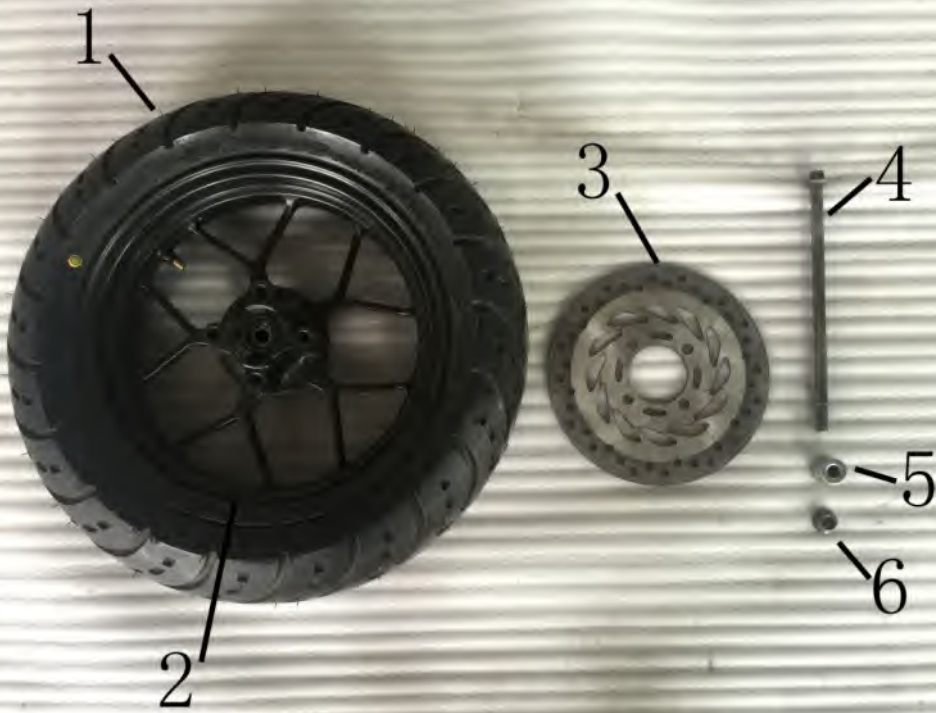

PMZ125-1-M-001	FRONT TIRE	1
PMZ125-1-M-002	FRONT RIM	1
PMZ125-1-M-003	FRONT BRAKE DISC	1
PMZ125-1-M-004	FRONT AXLE (no spacer)	1
PMZ125-1-M-005	BUSHING	1
PMZ125-1-M-006	NUT	1





PMZ125-1-N-001	HEADLIGHT	1
PMZ125-1-N-002	REAR LIGHT	1
PMZ125-1-N-003	SPEEDOMETER	1
PMZ125-1-N-004	REAR TURN LIGHT	1
TBD	BRAKE LINE CLAMP	
NO DIAGRAM	CHAIN	
	FRONT AXLE SPACER	
TBD	CLUTCH	
TBD	CLUTCH SENSOR	
TBD	EXHAUST GASKET	
NO DIAGRAM	FRONT BRAKE PADS	
TBD	FRONT SPROCKET COVER	
TBD	REAR HUB SPACER	
NO DIAGRAM	MAGNETO	
NO DIAGRAM	REAR BRAKE PADS	
NO DIAGRAM	REAR MASTER LINKAGE	
NO DIAGRAM	REAR MASTER LINKAGE, SPACING	
NO DIAGRAM	ROTOR HARDWARE	
NO DIAGRAM	STATOR	